

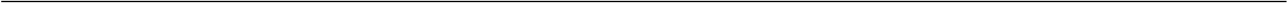

CI Digital to Analog Controller

User Manual





Dear Client,

We are honored that you have chosen the CH C1 Digital to Analog Controller. Our team has put all of our efforts into designing and manufacturing this top quality versatile and future-proof product and is proud to present it to you. We hope your C1 will bring you uncountable hours of emotion from your musical collection.

But before starting your musical journey, we kindly ask you to pay attention to the information contained in this manual. The C1, as you will discover in the following pages, is a Swiss precision product designed for ultimate performance and flexibility. However, reaching sonic excellence requires your unit to be setup and operated correctly and this is what this manual is all about. If you have any questions or require assistance, please don't hesitate to contact your authorized dealer.

We hope you will enjoy your C1 D/A Controller for many years.

The Concert has just begun...

Cossy F.

A handwritten signature in blue ink, consisting of a stylized 'C' followed by a horizontal line and a vertical stroke.

Heeb T.

A handwritten signature in blue ink, featuring a large, looped initial 'H' followed by a horizontal line and a vertical stroke.

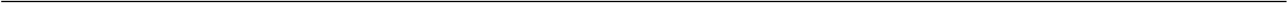



Table of contents

| | | |
|---------|---|----|
| 1 | Technical highlights..... | 7 |
| 1.1 | Digital to analog conversion..... | 8 |
| 1.1.1 | Clock management..... | 8 |
| 1.1.2 | Processing engine and PEtER upsampler..... | 8 |
| 1.1.3 | D/A conversion stage..... | 9 |
| 1.1.4 | Output stage..... | 9 |
| 1.1.5 | Volume control capability..... | 10 |
| 1.2 | Mechanical construction..... | 10 |
| 1.3 | Modular architecture and slot-in boards..... | 11 |
| 1.3.1 | Digital inputs and CH Link HD: DIGITAL_IN_HD board..... | 11 |
| 1.3.2 | USB audio input: USB_IN board option..... | 11 |
| 1.3.3 | Analog inputs: ANALOG_IN board option..... | 12 |
| 1.3.4 | External clock synchronization: SYNC_IO board option..... | 12 |
| 1.3.5 | Ethernet audio input: ETHERNET_HD board option..... | 12 |
| 1.4 | Power supply..... | 12 |
| 1.4.1 | Optional external power supply: X1..... | 13 |
| 2 | Before use..... | 14 |
| 2.1 | Package content..... | 14 |
| 2.2 | Safety notice..... | 14 |
| 2.3 | User manual..... | 15 |
| 2.4 | Mains supply..... | 15 |
| 2.5 | Transport and packaging..... | 15 |
| 2.6 | Cleaning..... | 16 |
| 2.7 | Maintenance and service..... | 16 |
| 3 | Installation..... | 17 |
| 3.1 | Unpacking..... | 17 |
| 3.2 | Unit positioning..... | 17 |
| 3.3 | Connections..... | 18 |
| 3.3.1 | CONTROL board..... | 20 |
| 3.3.1.1 | USB port..... | 20 |
| 3.3.1.2 | Ethernet port..... | 20 |
| 3.3.2 | ETHERNET_HD board..... | 21 |
| 3.3.2.1 | USB port..... | 21 |
| 3.3.2.2 | Ethernet port..... | 21 |
| 3.3.3 | DIGITAL_IN_HD boards..... | 21 |
| 3.3.3.1 | Standard digital inputs..... | 22 |
| 3.3.3.2 | CH Link HD digital audio interface..... | 22 |
| 3.3.4 | USB_IN boards..... | 22 |
| 3.3.4.1 | Microsoft Windows configuration (7, 8, 8.1 and 10)..... | 23 |
| 3.3.5 | ANALOG_IN boards..... | 23 |
| 3.3.6 | SYNC_IO board..... | 24 |
| 3.3.6.1 | BNC clock input..... | 24 |
| 3.3.6.2 | BNC clock outputs..... | 25 |
| 3.3.7 | Power cord receptacle and voltage selection..... | 25 |
| 3.3.8 | External power supply connector..... | 25 |



| | | |
|---------|---|----|
| 4 | Operation..... | 26 |
| 4.1 | Front panel controls..... | 26 |
| 4.1.1 | Front panel..... | 26 |
| 4.1.2 | User control knob..... | 26 |
| 4.2 | Operating modes..... | 28 |
| 4.2.1 | Normal mode..... | 28 |
| 4.2.2 | Shortcuts..... | 29 |
| 4.2.3 | Menu mode..... | 31 |
| 4.3 | Configuration..... | 34 |
| 4.3.1 | C1 configuration menu items..... | 35 |
| 4.3.1.1 | AUDIO SETTINGS..... | 35 |
| 4.3.1.2 | DISPLAY SETTINGS..... | 37 |
| 4.3.1.3 | SHORTCUTS..... | 38 |
| 4.3.1.4 | FACTORY SETTINGS..... | 39 |
| 4.3.1.5 | INSTALLED OPTIONS..... | 41 |
| 4.3.1.6 | NETWORK..... | 42 |
| 4.4 | Remote control..... | 43 |
| 4.4.1 | Remote control operation..... | 43 |
| 4.4.2 | Changing the remote control batteries..... | 44 |
| 4.5 | Advanced clocking..... | 44 |
| 4.5.1 | General clocking considerations..... | 44 |
| 4.5.2 | Without SYNC_IO board..... | 45 |
| 4.5.3 | C1 D/A controller (with SYNC_IO board) + D1 SACD/CD drive (with SYNC_IO board)..... | 46 |
| 4.5.4 | 3x C1 D/A controllers + multichannel D1 drive (all with SYNC_IO board)..... | 47 |
| 4.5.5 | D1 (with SYNC_IO board) + C1 (with SYNC_IO board) + T1 time reference..... | 48 |
| 4.5.6 | C1 D/A controller + Computer (USB audio)..... | 49 |
| 4.5.7 | C1 D/A controller + Server (Ethernet audio playback)..... | 49 |
| 4.6 | Returning to factory defaults..... | 51 |
| 5 | Firmware update..... | 51 |
| 5.1 | Preparing the USB stick..... | 51 |
| 5.2 | Updating the unit's firmware..... | 51 |
| 5.3 | Emergency firmware update procedure..... | 52 |
| 6 | Troubleshooting..... | 53 |
| 7 | Specifications..... | 55 |

1 Technical highlights

CH products are proudly designed and manufactured in Switzerland by CH Precision Sàrl. Our engineers have put all their know-how into bringing you the C1, a top performances future-proof digital to analog (D/A) controller, based on slot-in boards and USB flash-drive firmware update. In its base version the C1 is a four inputs D/A converter, with integrated preamplifier functions such as source selection and volume control. The default configuration also has one DIGITAL_IN_HD board and a CONTROL board. Audio inputs on each DIGITAL_IN_HD board include three standard digital audio connectors (RCA coaxial S/PDIF, TOSLINK optical S/PDIF and XLR AES-EBU) supporting S/PDIF encoded PCM up to 24bits/192kHz and DoP (DSD64 over PCM), as well as proprietary high definition CH Link HD interface, supporting both I²S PCM (up to 32 bits/768kHz) and native DSD audio signal connection.

Option boards allow you to extend the functionality of the base version of the C1 D/A controller. By adding extra option boards (a total of up to three input boards can be plugged in the unit), the C1 can be connected to even more standard digital sources. Addition of the optional USB_IN board and/or optional ETHERNET_HD board (replaces standard CONTROL board) unleashes the full capabilities of the C1 as the ultimate high-resolution audio file player. On the other hand, ANALOG_IN optional board will turn your C1 into a top quality preamplifier while offering single-ended RCA and balanced XLR analog inputs. Finally, the SYNC_IO optional board provides advanced clock synchronization capabilities for use with external clock generators such as the T1, or to enslave the D1 SACD/CD drive to the C1's Masterclock for near zero-jitter connection.

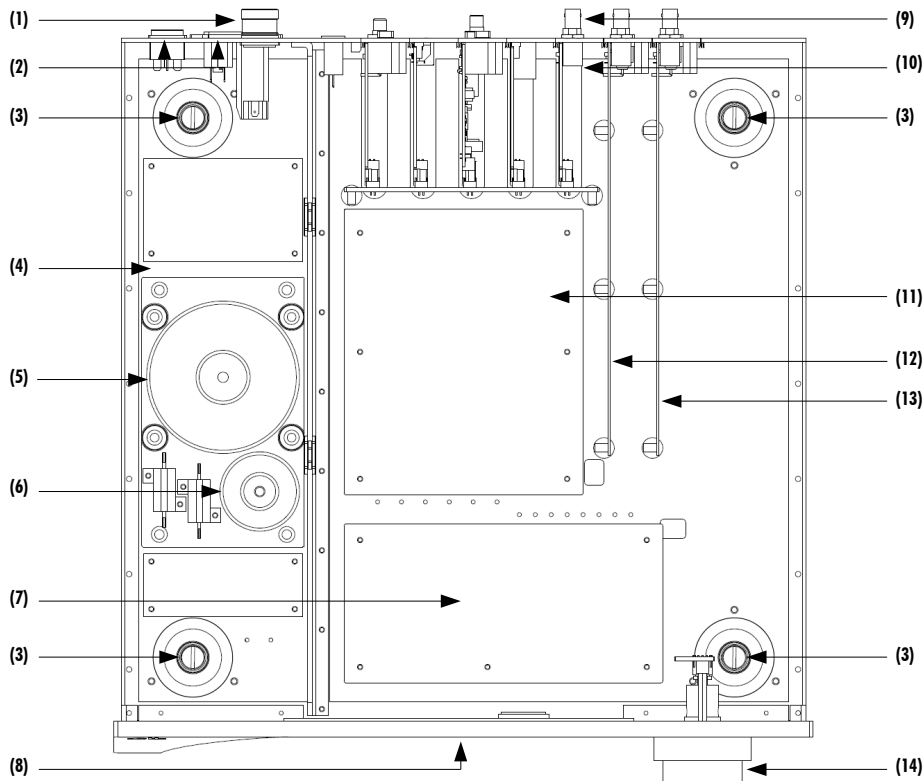

C1 main components

- (1) External power supply input. For X1 optional external power supply only
- (2) Mains switch and power cord receptacle (on back panel)



- (3) Adjustment shafts and screws
- (4) Power supply section
- (5) Main power transformer
- (6) Standby power transformer (ensures green mode Standby)
- (7) Power supply regulation board
- (8) AMOLED display (on front panel)
- (9) Audio in, clock in/out, USB (firmware update) and RJ-45 (control/network) connectors (from slot-in boards). Analog ground to Earth jumper
- (10) Slot-in boards (SYNC_IO, CONTROL/ETHERNET_HD, DIGITAL_IN_HD/USB_IN/ ANALOG_IN)
- (11) Main processing and control board
- (12) Left channel DAC board
- (13) Right channel DAC board
- (14) Concentric push control knob

1.1 Digital to analog conversion

The C1 D/A controller is built around CH-PEtER (Polynomial Equations to Enhance Resolution), a synchronous processing engine feeding two first grade factory-calibrated monaural D/A conversion boards. The conversion stage is a linearized R2R topology, followed by a fully discrete output stage. The whole purpose of this design is not only to reconstruct correct level information but also perfect timing, since it is the key element for recreating nature-like immersion into a musical performance.

1.1.1 Clock management

The first requirement to achieve perfect timing is that audio data are fed into the DAC chips synchronously to a jitter-free clock. This is why two high-precision low-drift audio crystal clock oscillator (22.5792 MHz for 44.1 kHz multiples and 24.576 MHz for 48 kHz multiples) are located only a few cm away from the DAC chips. The clocking section has its own dedicated power supply fully decoupled (complete galvanic isolation) from all noisy digital signals. This critical Masterclock signal is carried to the DAC chips in LVDS (low-voltage differential signaling) form to avoid any cross-talk pollution.

In order to be synchronous to the incoming audio signal, these crystal oscillators can be fine tuned using a voltage controlled feedback (VCXO), computed by a proprietary algorithm. Performances of this “digital phase-locked loop” (digital PLL) has a jitter rejection below 0.1 Hz, while frequency tracking is achieved through sub 0.1 PPM correction steps. Phase alignment is also guaranteed with a ± 2.5 μ s accuracy. When combined with matching CH D1 SACD/CD drive and optional synchronization boards (or a computer source), the C1 can even be configured as the clock master, having the source (either CH D1 or computer) clock-enclaved. In such configuration, the C1’s oscillators are running at their natural frequency, which leads to extremely low jitter. Correcting the very slow drifts of the C1’s internal clock with the addition of a 10MHz TI clock generator stabilizes the DAC’s Masterclock even further (and with it the sound stage) to an unprecedented level.

1.1.2 Processing engine and PEtER upsampler

After years of development in the high-end audio industry we came to the conclusion that the digital samples contained in the DAC’s input audio stream should remain untouched through the upsampling process, only computing missing information between them to remove most of the burden (and phase non-linearity) off the analog filtering stage. Compared to widely-used asynchronous sample rate conversion (ASRC), synchronous upsampling removes all harshness often found in digital players.

Bringing the acclaimed CH-HiD minimum phase upsampling algorithm initially found in the C1 one step closer to the original analog signal, CH team developed its successor, the PEtER (Polynomial Equations to Enhance Resolution) upsampling algorithm.



Any existing CI can benefit from it, as soon as its legacy DIGITAL_IN board is replaced by the new DIGITAL_IN_HD board. This new upsampling technique dramatically decreases temporal smearing associated with classical linear-phase and minimum-phase interpolation filter, leading to a more fluid and natural sounding music reproduction than ever before.

The 4.8GFLOPS DPS engine used for each channel performs several tasks, including synchronous spline-based PEtER upsampling (to 705.6/768 kHz), DSD to PCM conversion (SACD and DFF/DSF file playback), volume control, resolution enhancement and linearity enhancement (proprietary scrambling algorithm).

1.1.3 D/A conversion stage

The digital to analog conversion stage of each channel is handled by four Burr-Brown PCM 1704 R2R chips.

While total harmonic distortion (THD) figure of top R2R conversion chips is slightly less impressive than those of Delta-Sigma technology based converters, their temporal behavior (on transient events which music is filled with) is inherently better. The high frequency behavior (above 20 kHz) is also much more accurate and free from modulation noise that often disrupts treble speakers (tweeters), as high energy content into the 20 kHz -100 kHz band can not be handled properly by most tweeters.

Combining four PCM 1704 the way it is done in the CI enables improved THD figures compared to individual conversion chips and to exploit their full output range (scrambling) which leads to an enhanced linearity, especially for small signal modulation (which is common in the CI, especially when used as a preamplifier with volume control).

In order to achieve reproductive audio performances through our production, each chip used for a single channel should be identical, including gain and offset. Unfortunately, tolerances on these parameter is rather loose. In order to avoid costly manual component measurement and matching (or disparity of the audio performance of a production batch), we have introduced a fully automated calibration process that is factory-performed, and can also be run by customer to keep top performances over time. During this calibration process, the DSP sets several codes to each individual DAC chip, while a dedicated analog to digital converter (ADC) measures the resulting voltage. The DSP is then able to compensate for any disparity across DAC chips on a DAC board.

1.1.4 Output stage

Each PCM 1704 chip outputs an analog current which reflects the digital code fed to the CI.

It is first converted by an ultra-fast current to voltage stage (I-V). The bandwidth of this stage has to be very wide, in order not to distort (i.e. add harmonic distortion) the staircase shape of the sample-and-hold DAC chip output.

A fully discrete low-pass filter without feedback comes next, to smooth out the voltage signal without generating in-band phase shift.

Finally, a differential output stage with high output current capability follows, driving single-ended 75 Ohm RCA, single-ended 50 Ohm BNC and fully-balanced XLR connectors.



1.1.5 Volume control capability

The C1 can be used as a pure DAC (digital to analog converter) together with an analog line preamplifier. But it can also be used as a controller, directly feeding power amplifiers. The latter allows volume control in the range of -95.5 dB to +24.0 dB (in 0.5dB steps). Positive gain (+0.5 dB to +24.0 dB) is only possible when the incoming signal is lower than 0 dBFS (full scale). Otherwise, the C1 will automatically decrease the volume in order to avoid any clipping. Left/right balance correction is also available in a +/- 6dB range (with 0.5dB steps).

The C1's hybrid volume control is achieved by a unique combination of analog attenuators and high resolution digital multiplication.

When the volume is set in the range -95.5 dB to -12.5 dB, a 12 dB analog attenuator is engaged, and the DSP attenuates (i.e. multiply the audio sample in 32 bits floating point resolution) by [volume + 12 dB].

When the volume is set between -12.0 dB and -6.5 dB, a 6 dB analog attenuator is engaged, and the DSP attenuates by [volume + 6 dB].

When the volume is in the range -6 dB to 0dB, no analog attenuator is engaged, and the DSP attenuates by [volume].

When the volume is positive (i.e. +0.5 dB to +24.0 dB), no analog attenuator is engaged, and the DSP applies a positive gain corresponding to [volume], whenever possible. If the DSP detects that the upcoming resulting samples will digitally clip (sample value * volume > 0 dB full scale), it will soft clip this event and automatically decrease the volume to a value that will avoid clipping in the future.

1.2 Mechanical construction

The C1 D/A controller is assembled from high-grade aluminum and steel elements with no visible screws on the front, top and side panels. The front panel, base, side panels and top cover are machined from solid aluminum. The power supply is isolated from the audio section in its own compartment to avoid any contamination of the audio circuits by noise radiated from the supply. Pin assembly of all chassis elements provides smooth joints between elements while screws every 6cm ensures protection against electromagnetic interference. First class mechanical and chemical surface treatments provide the luxury finish of the C1.

Four steel feet support the unit. Each feet ends with an O-ring to sit on delicate surfaces but is also equipped with a height adjustable steel spike to fine tune unit positioning. The steel spikes are to be used in conjunction with the provided polymer support discs, or the polymer stacking covers on the top of another CH unit. Horizontal adjustment is done with the provided screwdriver through the four adjustment shafts accessible from the top of the unit. In addition to providing convenient horizontal adjustment from the top of the unit, the shafts also serve as vibration evacuation channels for any stacked unit. Special shaft covers are provided to interface with the spikes of the stacked unit. Any vibration from the upper unit is transmitted by the shaft cover to the shaft and from the shaft to the lower unit feet or spike, forming a privileged path for vibrations evacuation.

1.3 Modular architecture and slot-in boards

The CI benefits from a fully modular architecture. It features separated sections for power-supply, front panel, computing + signal/clocks routing + central host processor, slot-in boards and monaural conversion boards. This modular architecture combined with the USB port for all firmwares (MCU, DSPs and FPGAs) updates allows for easy servicing and upgrade should one section become faulty or obsolete.

The slot-in boards section consists of a vertically mounted mother board with optional boards plugged into it. Optional boards provide audio functionality and connectivity to other equipment. There are six types of slot-in boards:

- **DIGITAL_IN_HD**: provides three standard S/PDIF-encoded digital audio input plus a proprietary CH-Link HD input
- **USB_IN**: provides asynchronous USB audio (PCM up to 24bits/384kHz, DSD up to 5.6448MHz) input. Computer is enslaved to the CI, sending audio data at a CI-specified average rate
- **ANALOG_IN**: provides single-ended RCA and balanced XLR analog audio input
- **SYNC_IO**: provides advanced clock synchronization options (one clock input, two clock outputs)
- **CONTROL**: provides a USB port for software upgrade and an Ethernet port for network remote control.
- **ETHERNET_HD**: optional board used to upgrade the CONTROL board slot. Provides an Ethernet input that is recognized as a Roon Ready endpoint or UPnP port for high resolution audio playback, and a USB port for software upgrades.

There are five slots in the CI. Three of them can be populated with any combination of DIGITAL_IN_HD, USB_IN and ANALOG_IN boards. One of them is dedicated to the optional SYNC_IO board while the last one is default loaded with a CONTROL board, but can be upgraded to an ETHERNET_HD board for Roon Ready and UPnP Ethernet streaming capability. Note: optional boards MUST be installed by a qualified technician. Failure to do so will void any warranty.

1.3.1 Digital inputs and CH Link HD: DIGITAL_IN_HD board

Each DIGITAL_IN_HD board provides standard digital inputs in XLR (AES-EBU), Coaxial RCA (S/PDIF) and Optical TOSLINK (S/PDIF) formats as well as in the CH Link HD high-definition proprietary format. CH Link HD uses a dedicated connector to carry high resolution audio and control data over a single link between CH units. It supports both PCM (up to 768kHz, 32bits) and DSD. To comply with high definition digital content protection, DSD signals are cyphered when transported over CH Link HD from the DI to the CI. On its standard digital input connectors, CI can lock to incoming S/PDIF modulated 16 or 24 bits PCM audio, at sample rates of 44.1, 48, 88.2, 96, 176.4 or 192 kHz, +/- 80 PPM, as well as DoP encoded DSD64 at 2.8224MHz

1.3.2 USB audio input: USB_IN board option

The USB_IN board provides asynchronous USB audio input. Asynchronous mode means that the CI is the clock master, and the computer is the clock slave. Therefore no jitter is imported from the computer world. Moreover, all noisy digital devices on this board (such as the DSP) are powered by the USB port (i.e. by the computer), and are galvanically isolated from the rest of the CI. The USB input can be configured (in CI's menu) as audio class 1.0 (no driver required, Fs limited to 96kHz) or as audio class 2.0 (a driver is needed for Microsoft OS older than Windows 10, PCM with Fs up to 384kHz and DSD up to 5.6488MHz are supported).



1.3.3 Analog inputs: ANALOG_IN board option

The ANALOG_IN board features two stereo analog input on two connector pairs: a single-ended RCA pair and a balanced XLR pair. The analog stage design is fully discrete. One can find high-grade A/D conversion chip on this board, using the same high-precision low-jitter clock signals as the two monaural DAC boards. The analog data are sampled at the rate of 5.6448 MHz (DSD128) before entering one 32 bit floating point DSP per channel. This option turns the C1 into an analog preamp.

1.3.4 External clock synchronization: SYNC_IO board option

The SYNC_IO board provides advanced clock synchronization options for C1 when used with an external clock generator such as the CH Precision T1 10MHz time reference or matching CH source (such as the D1). It includes a clock input on BNC connector with selectable 75 Ohm or high input impedance. Supported input frequencies on this connector are all standard audio Wordclocks (44.1, 48, 88.2, 96, 176.4, 196, 352.8 and 384 kHz), audio Masterclocks (22.5792 and 24.576 MHz), DSD bitclock (2.8224 MHz) and atomic-clock multiples (100 kHz and 10 MHz). When fed with an audio Wordclock, the C1's internal clock will lock its VCXO internal clock in frequency and in phase (phase accuracy of +/- 2.5 us), tracking below 0.1 Hz with 0.1 PPM corrections for optimal jitter rejection.

Two 75 Ohm Wordclock outputs completes the input/output capabilities of the SYNC_IO board.

When a T1 time reference clock generator is available, ultimate result is achieved when connecting both the C1 and the D1's clock input to two different clock outputs of the T1, and setting both C1 and D1's clock source to SYNCHRO BNC 75. If no ultra-high stability external clock source is available but both C1 and D1 are equipped with a SYNC_IO board, the optimal configuration is to set the C1 as the clock master (C1 clock source: INTERNAL), and D1 as the clock slave (D1 clock source: SYNCHRO BNC 75). In that case, connect one of C1's BNC clock out to D1's clock in configured as a 75 Ohm input with a 75 Ohm BNC-terminated cable.

When playing audio files from the USB audio or the Ethernet_HD audio inputs, only the C1 can be clocked by an external 10MHz reference clock generator. As opposed to a standard S/PDIF connection (where the source is generally clock master), neither the computer connected via USB nor the Ethernet network needs to receive this synchronization clock (as they are already enslaved to the C1 through a computer/network protocol).

1.3.5 Ethernet audio input: ETHERNET_HD board option

The CONTROL board can be replaced by an ETHERNET_HD board, providing all the features of the CONTROL board, plus Ethernet based audio playback from a local Roon server, local UPnP server, web-radios, and streaming services such as Tidal or Qobuz (Roon, Qobuz and Tidal require valid subscriptions). High resolution audio formats are supported, and the complete system is enslaved to the C1's internal clock for jitter-free playback. When the ETHERNET_HD board is installed, an additional digital input appears on the C1: Roon Ready. Select this input to stream digital music files to the C1 from a local Roon server. Select the ETHERNET input to stream files to the C1 from a local UPnP server using CH Control app or any iOS/Android UPnP remote control app.

1.4 Power supply

The power supply of the C1 is a linear supply with multiple independent local regulations. It is based on an oversized magnetically shielded toroidal mains transformer and includes a mains filter. A secondary (also toroidal) transformer is used as Standby transformer to ensure green Standby mode, meeting the latest energy saving regulations. Both transformers have static shields



between primaries and secondaries. They are mounted on a separate steel plate which is isolated from the main base aluminum plate by silent blocks.

Discrete (power-transistor and op-amp based) ultra-low noise regulators are used throughout the power supply and special care has been paid to the Masterclock power supply. The Masterclock benefits from its own dedicated supply, completely decoupled from the digital sections. This ensures an ultra-low jitter clock source for the whole system.

Input AC voltage to the power supply can be set to 100V, 115V or 230V AC depending on your local mains voltage.

1.4.1 Optional external power supply: X1

The CI is equipped with an external power supply input. This input is dedicated to the CH X1 external power supply. When the external power supply is connected, the internal power supply of the CI is turned off (only the Standby transformer remains active). Turning the main internal transformer off ensures that no power supply induced noise or radiations are generated inside the CI unit, thus permitting optimal operating conditions for the circuits. Moreover, the CI's internal voltage regulation stage are still active, cascaded with the X1's regulation stages, significantly lowering the noise floor.



2 Before use

Please read this manual carefully before making connections or operating your C1. After reading this manual, please store it in an accessible place for future reference. If after reading this manual you feel unsure about how to make connections or how to operate the unit, please contact your authorized dealer for assistance.

2.1 Package content

Make sure that the package content is complete. If not, please contact your authorized dealer. Your package should contain:

- C1 D/A controller
- A mains power cord
- Four adjustment steel spikes (located in the packaging's bottom piece of foam)
- A suction cup used to unscrew the top covers (located in the packaging's top piece of foam)
- An accessory box containing:
 - an infrared remote control
 - a spike adjustment screwdriver
 - a Torx T10 screwdriver
 - four stacking covers
 - a USB stick containing the latest CH Precision piece of firmware and user manuals.
 - four CH Support Discs

Please store the packaging for future use. Check your C1 for any apparent damage. In case of a damage, immediately contact your authorized dealer. If your C1 is cold due to transport, please let it warm up to room temperature before powering it up.

2.2 Safety notice

Make sure to observe the following rules:

- Install your C1 D/A controller on a stable base
- Do not install your C1 D/A controller near water
- Always handle with care. The C1 D/A controller is quite heavy, so have someone help you when moving it around



- Do not expose the unit to liquids
- Do not install in direct sunlight or near any heat source such as radiators or other apparatus generating heat
- Do not install in a confined space and make sure sufficient air can flow around the unit
- Do not operate under high ambient temperature ($>40^{\circ}\text{C}$) or with extremely high humidity such as in humid cellars
- Only use options and accessories specified or recommended by the manufacturer
- Do not open the unit nor try to service it by yourself. Do not try to install any option board by yourself. Always refer to a qualified technician for service, maintenance or upgrades. Failure to do so will void the unit's warranty

2.3 User manual

Please read this manual carefully before making connections or operating your CI D/A controller. After reading, store the manual in an accessible place for future reference. If, after reading this manual, you feel unsure about how to make connections or how to operate the unit, please contact your authorized dealer.

2.4 Mains supply

Make sure to use 3 terminals (phase, neutral and earth) power cords with ground conductor. Make sure that the mains voltage selection of the unit matches your mains voltage.

Make sure your CI D/A controller is disconnected from AC wall power in the following cases:

- When making connections (it is also recommended to disconnect the rest of the system from AC wall power)
- When cleaning
- During thunderstorms
- When unused for a long period of time

2.5 Transport and packaging

The CI D/A controller must always be stored in its original packaging for transportation. Doing so will ensure optimal level of protection of your unit. Therefore, keep all the packaging material in a dry and clean place for future use.

Besides, we recommend to remove the adjustment spikes and to put them into the CI box for transportation. Indeed, vibrations during transport may cause the adjustment spikes to move from their fully retracted position. There is risk of scratching the installation base if the spikes are not fully retracted when re-installing the unit.



2.6 Cleaning

Use a soft, dry towel or cloth for cleaning. Never use any solvent or liquids as they may damage the surface treatment or penetrate inside the unit.

Use a microfiber cloth, such as the ones used to clean eyeglasses to clean the front panel display

2.7 Maintenance and service

The CI D/A controller contains no user serviceable parts. Do not try to open, modify or repair your CI by yourself. This will void any warranty. Your CI D/A controller must be checked by a qualified technician in any of the following cases:

- The unit is not functioning properly
- The mains cable or the power cord receptacle is damaged
- The unit has been dropped to the floor or presents external damage
- The CI D/A controller has been exposed to liquids (such as rain) or unknown substances



3 Installation

3.1 Unpacking

Unpack the C1 D/A controller and store the packaging for future transportation. Be careful when lifting the C1 as the unit is heavy (over 20kg). Get someone to help you if necessary. When unpacking and installing the C1, take great care not to damage the high quality surface treatments for example from rings or watches you may wear.

3.2 Unit positioning

When delivered from factory, the C1 D/A controller's four feet sit on O-rings, ensuring both scratch-protection for the base on which the unit sits, as well as safe anti-slipping unit positioning.

But a more advanced vibration-channeling mechanical coupling can be implemented, thanks to the steel spikes and the polymer support discs provided with the C1. To use this optimal coupling, simply go through the following steps:

1. Place the C1 unit on a stable base at its approximate final position, for instance in your preferred audio rack. Make sure cooling air is able to freely flow around the unit.
2. Gently lift the unit's corners and insert a support disc under each foot. When properly placed, the foot's O-ring should disappear in the support disc's groove. Carefully check all four feet perfectly fit in each support disc before pursuing any further. The unit should rest stably at that point.
3. Unscrew the four top covers from the C1's shafts with the provided suction cup.
4. Insert the adjustment spikes into each adjustment shaft.
5. Softly screw clockwise each adjustment spikes into the shaft with the provided screwdriver, until some resistance is felt (just before the unit's starts to lift).
6. Then screw clockwise each spike by the same amount (for instance two full revolutions).
7. If the base is flat, the unit should be stable and horizontal. If not, correct the unit's stability and horizontal position by turning clockwise or anti-clockwise the required spikes.
8. If no CH Precision unit is to be stacked on top of the C1, screw the four top covers back. Otherwise, screw the four polymer stacking caps instead, and gently lay down the unit to be stacked on top of it. Be very careful that both units are perfectly aligned in order not to scratch the C1's top plate with the other unit's feet. Repeat steps 3 to 8.

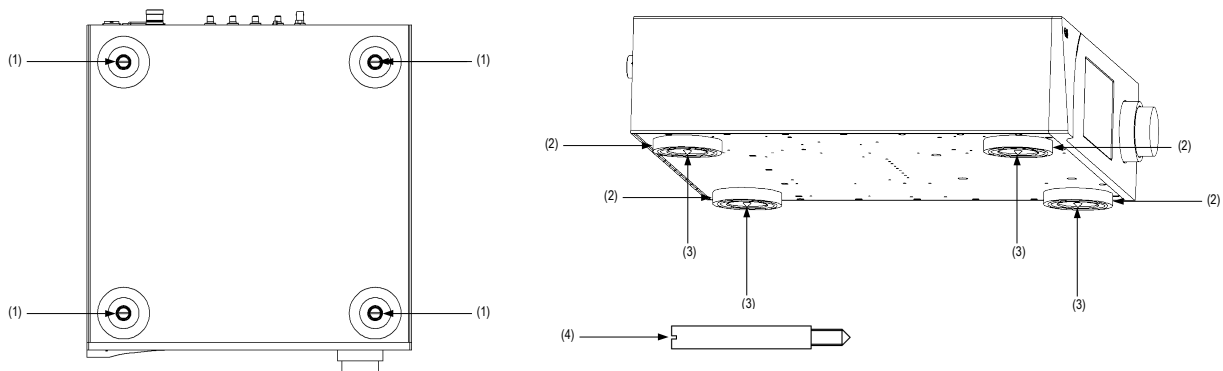

Adjustment shafts, feet and spikes

- (1) Adjustment shafts. Insert adjustment spikes and use screwdriver to secure and adjust individual feet spikes
- (2) Feet
- (3) Adjustment spike heads (when inserted into adjustment shafts)
- (4) Adjustment spike

Never stack any component other than CH's on your C1. Never use the aluminum shaft covers (top covers) when another CH component is to be stacked on top of your C1.

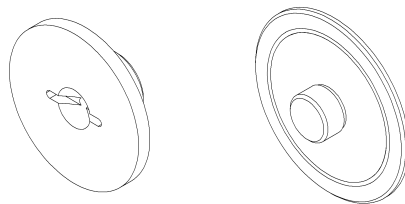

Shaft covers (left: stacking cover, right: top cover)

3.3 Connections

This section provides information about how to connect your C1 D/A controller to your system. As the C1 is a modular design with different optional boards, the description applies to the example configuration presented below. If your options do not match the example or you feel unsure with the connections to be made to your configuration, please contact your authorized dealer for assistance.

The example configuration is a full featured controller with many inputs (standard digital input AES-EBU, Coaxial and Optical, CH-Link HD, USB and balanced and single-ended analog in) and clock synchronization option (SYNC_IO board). This is one of the most complete configurations of C1. If your configuration does not include some of the presented options, just discard the corresponding connections.

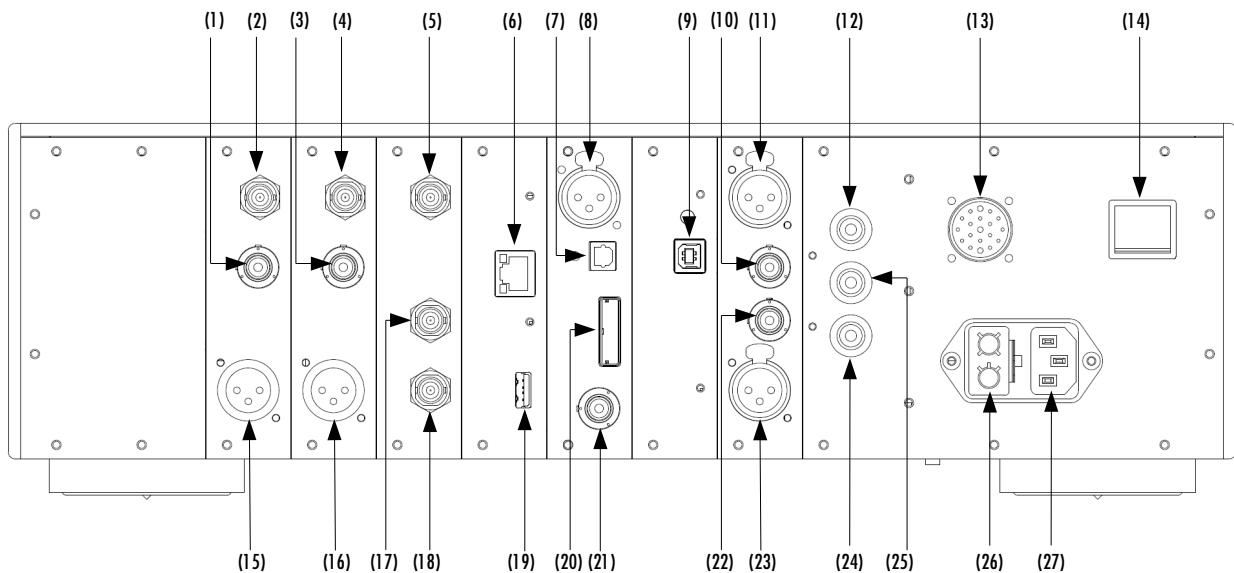

Rear panel connections

- (1) 75 Ohm RCA single-ended analog output for right channel
- (2) 50 Ohm BNC single-ended analog output for right channel
- (3) 75 Ohm RCA single-ended analog output for left channel
- (4) 50 Ohm BNC single-ended analog output for left channel
- (5) BNC clock input. Provides 750hm or Hi-Z input. [optional SNYC_IO board]
- (6) Ethernet port for command interface [CONTROL board] or for audio playback and commands [optional ETHERNET_HD board]
- (7) TOSLINK (S/PDIF) digital input [DIGITAL_IN_HD #1 board]
- (8) AES-EBU digital input [DIGITAL_IN_HD #1 board]
- (9) USB audio [optional USB_IN board]
- (10) RCA single-ended analog input for left channel [optional ANALOG_IN board]
- (11) XLR balanced analog input for left channel [optional ANALOG_IN board]
- (12) Earth connector. Internally connected to digital ground
- (13) External power supply connector for X1 power supply option
- (14) Power on/off switch
- (15) XLR balanced analog output for right channel
- (16) XLR balanced analog output for left channel
- (17) BNC 75 Ohm clock output 2. [optional SYNC_IO board]
- (18) BNC 75 Ohm clock output 1. [optional SYNC_IO board]
- (19) USB port for software upgrades. [CONTROL board or optional ETHERNET_HD board]
- (20) CH Link HD digital input [DIGITAL_IN_HD #1 board]
- (21) Coaxial (S/PDIF) digital input [DIGITAL_IN_HD #1 board]
- (22) RCA single-ended analog input for right channel [optional ANALOG_IN board]
- (23) XLR balanced analog input for right channel. [optional ANALOG_IN board]
- (24) Analog ground connector 2
- (25) Analog ground connector 1. Can be connected to digital ground (Earth) using provided jumper
- (26) Power fuse and voltage selection
- (27) Power cord receptacle

The CONTROL board is mandatory in any CI configuration and is always factory installed. It can be upgraded by an optional

ETHERNET_HD board that replaces it, providing all functions of the CONTROL board plus adding Room Ready and Ethernet UPnP/DLNA audio playback capability. Depending on optional boards and their arrangement in the C1 's expansion slots, connector arrangement may differ on your unit. Each C1 unit provides 4 expansion slots supporting any combination of the following optional boards (note that one slot is dedicated to the SYNC_IO board):

- DIGITAL_IN_HD boards (one is already installed in the default C1 configuration) provides 4 digital inputs (coaxial S/PDIF, optical TOSLINK, AES-EBU and CH-Link HD)
- USB_IN boards provides an asynchronous USB audio input
- ANALOG_IN boards provides 2 pairs (L+R) or analog inputs (balanced XLR and single-ended RCA)
- SYNC_IO board for external clock synchronization

Note that only one SYNC_IO board is allowed. Optional input boards can be placed in any slot. Installation of optional boards must be done by a qualified technician only. Do not attempt to install any optional board by yourself as this would void the unit's warranty.

3.3.1 CONTROL board

The CONTROL board is factory installed into the C1. It provides a USB port for software updates and an Ethernet port for controlling the unit over a network thanks to the CH Control Android app. Following drawing shows the layout of the back panel of the CONTROL board:

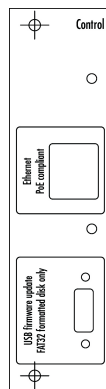

CONTROL board back panel layout

3.3.1.1 USB port

The USB port on the CONTROL board is dedicated to the firmware update of the C1 unit. Do not use it for any other purposes. For more information on unit firmware update, please refer to the corresponding section of this manual.

3.3.1.2 Ethernet port

The Ethernet port on the CONTROL board is dedicated to network remote controlling. Connect the C1 Ethernet port to an off-the-shelf Ethernet router equipped with WiFi access using a standard RJ45 Ethernet cable. Connect an Android tablet to the WiFi



network of the router. Install on the Android tablet the CH Control app, freely available from the Google Play Store or CH Precision's website. Once installed, run the app. The app gives you access to all the settings of the CI.

3.3.2 ETHERNET_HD board

The optional ETHERNET_HD board can replace the default CONTROL board. It provides all the features of the CONTROL board (firmware update USB port, control through CH Control Android app) plus, it converts the CI into a Roon Ready or UPnP/DLNA network player when connected to a Roon or UPnP/DLNA music server or streaming service through the local Ethernet network. Two digital inputs are available on the CI for Ethernet based file streaming: Roon Ready to stream files from a local network attached Roon Server and ETHERNET to stream files to the CI from a local UPnP/DLNA server. The following drawing shows the layout of the back panel of the ETHERNET_HD board:

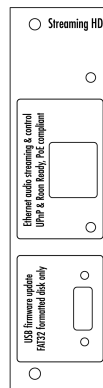

ETHERNET_HD board back panel layout

3.3.2.1 USB port

The USB port on the ETHERNET_HD board is dedicated to the firmware update of the CI unit. Do not use it for any other purpose. For more information on unit firmware update, please refer to the corresponding section of this manual.

3.3.2.2 Ethernet port

The ETHERNET_HD board adds music playback capability to the Ethernet port of the CI through two digital inputs: Roon Ready and UPnP streaming. While complete configuration of the unit from CH Control Android app remains at the tip of your fingers, this port also adds network music playback functionality to the CI. Whether you play high resolution files using Roon as your file server and music management system, or playback stored files from your local UPnP/DLNA NAS, or stream music from your Tidal or Qobuz account directly from the Internet, or listen to your favorite Web-radio, the audio stream will enter the CI through this common RJ45 Ethernet connector. NOTE: valid subscriptions are required for use of Roon, Qobuz or Tidal.

3.3.3 DIGITAL_IN_HD boards

DIGITAL_IN_HD boards provide digital audio input capabilities. Additional DIGITAL_IN_HD boards (#2 and #3) can be added to the default factory installed DIGITAL_IN_HD #1 into the CI to add inputs of each type. DIGITAL_IN_HD boards provide both standard (AES-EBU, Coaxial S/PDIF and Optical) digital audio inputs and a proprietary (CH Link HD) high-definition digital audio interface. The following drawing shows the layout of the DIGITAL_IN_HD board connectors:

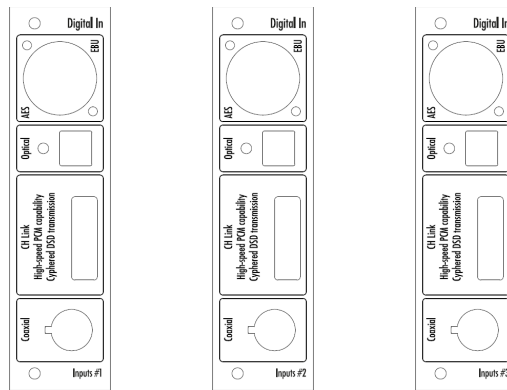

DIGITAL_IN_HD boards back panel layout

3.3.3.1 Standard digital inputs

Each DIGITAL_IN_HD board provides three standard digital inputs: AES-EBU (carrying consumer encoding), Coaxial (S/PDIF) and Optical (TOSLINK). Audio format supported are 16 or 24 bits, 44.1, 48, 88.2, 96, 176.4, 192 kHz sampling frequency.

3.3.3.2 CH Link HD digital audio interface

Each DIGITAL_IN_HD board includes a CH Link HD proprietary digital audio interface. This interface carries both complete audio stream and control information. Use this link as the preferred interface when connecting your C1 to CH sources such as the D1 SACD/CD unit.

The proprietary CH Link HD digital audio interface allows for high definition uncompressed digital audio transfer and supports both DSD and PCM (up to 705.6 / 768 kHz). For digital content protection reasons, the native DSD stream is cyphered on the CH Link HD interface. Of course, all CH sources (such as D1) and receivers (such as C1) use the same encoding/decoding key.

3.3.4 USB_IN boards

Optional USB_IN board provides connectivity to a USB port of a computer. Audio is sent from the computer to the C1 at a rate that is synchronous to the C1's precision internal Masterclock. The following drawing shows the layout of the USB_IN board connector:

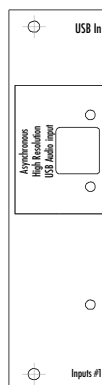

USB_IN boards back panel layout

Apple MAC OS X Snow Leopard V10.6.4 or above natively supports USB Audio Class 2.0, allowing 24bits/384kHz files playback.



Microsoft Windows 10 release 1703 or above also comes natively with a USB Audio Class 2.0 driver.

For older MS Windows versions (supporting only USB Audio class 1.0 with 24bit/96kHz maximum playback rate), a custom driver can be downloaded from the CH Precision website.

Most other audio file players run a custom version of Linux which also natively support USB Audio Class 2.0.

DSD files need USB Audio Class 2.0 to be active and they are packed into a 24bit/176.4kHz (for DSD64; 352.8kHz for DSD128) PCM carrier signal for bitstreaming. The CI supports the DSD over PCM (DoP1.0) format, automatically unpacks it and converts the DSD bitstream without any loss.

3.3.4.1 Microsoft Windows configuration (7, 8, 8.1 and 10)

The CI USB Audio input should not be the MS Windows default audio output device. In addition, Windows should be configured to allow applications to get exclusive access to the CI USB Audio input. Below is a list of recommended media players, drivers and related configurations to be used with the CI USB audio input.

| | USB Audio Class | Output support | Required component | Driver | Configuration |
|--|-----------------|--------------------|--------------------|-----------------------------------|------------------------------------|
| Foobar http://www.foobar2000.org freeware | 1.0 | ASIO | foo_asio | asio4all | Buffer ≥ 8s |
| | 2.0 | WASAPI EVENT STYLE | foo_out_wasapi | ch_usb_driver_pid307B_v4.11.0.zip | Output 24bits |
| J. River Media Center http://www.jriver.com commercial | 1.0 | WASAPI EVENT STYLE | - | - | H/w buffer = 50ms Output 24bits |
| | 2.0 | WASAPI EVENT STYLE | - | ch_usb_driver_pid307B_v4.11.0.zip | H/w buffer = 50ms Output 24bits |

Recommended media players, drivers and related configurations

3.3.5 ANALOG_IN boards

ANALOG_IN boards provide analog audio input capabilities. Even though the CI is primarily a high-grade digital to analog converter, adding one or two ANALOG_IN boards turns it into a complete preamplifier with both analog and digital inputs. Each ANALOG_IN board adds one RCA single-ended analog input pair and one XLR balanced analog input pair.

In order to achieve optimum performance from an analog source, the ANALOG_IN board converts the incoming analog audio signal into a high resolution digital audio stream (5.6448MHz DSD128) synchronously to its digital to analog output conversion stage. The volume control is also achieved by an optimized combination of analog attenuators and high precision 32 bits floating point multiplication in the digital domain. The following drawing shows the layout of an ANALOG_IN board connector:

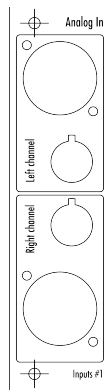

ANALOG_IN panel layout

3.3.6 SYNC_IO board

The SYNC_IO board is an optional clock synchronization board to be used with an external clock generator like the CH Precision T1, or together with other CH sources, such as the D1 SACD/CD unit. The board provides one clock input and two clock outputs on BNC connectors. Each VCXO digital PLL (one is based on a 22.5792 MHz Masterclock and the other one on a 24.576 MHz Masterclock) of the CI is capable of frequency and phase locking. The frequency is tracked below 0.1 Hz with 0.1 PPM adjustments for optimal jitter rejection. When fed with an audio Wordclock, the CI's internal clock will always keep a phase accuracy below 2.5 us (equivalent to sub-millimeter position accuracy), thus enabling phase perfect match in a multichannel configuration. The following diagram shows the layout of the back panel of the SYNC_IO board:

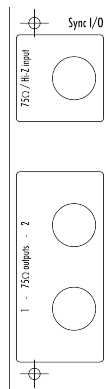

SYNC_IO board back panel layout

3.3.6.1 BNC clock input

The SYNC_IO board provides a BNC clock input that can be configured as 75 Ohm input impedance or high input impedance through the CI's menu. Supported input frequencies on this connector are all standard audio Wordclocks (44.1, 48, 88.2, 96, 176.4 and 196 kHz), audio Masterclocks (22.5792 and 24.576 MHz), DSD bitclock (2.8224 MHz) and atomic-clock multiples (100 kHz and 10 MHz). Use this connector to synchronize your CI unit to an external clock source (10MHz clock generator such as the T1 or external source such as CH D1).



3.3.6.2 BNC clock outputs

Two 75 Ohm output clock connectors are also provided on the SYNC_IO board. Use one of these connectors to synchronize an external device to your CI. Output clock is either a buffered version of input clock (if CI is synchronized to its input clock), or current audio Wordclock (if CI is clocked by its internal high precision oscillator).

3.3.7 Power cord receptacle and voltage selection

Make sure that the voltage selection is set to the correct value with respect to the AC voltage in your location. Connect the power cord to the power cord receptacle and plug the power plug to an AC wall outlet only after all other connections have been made.

3.3.8 External power supply connector

The external power supply connector allows you to connect the X1 optional external power supply. When the X1 is used, it completely replaces the CI's internal power supply, resulting in minimized noise and enhanced audio quality. Note that only the (small) standby transformer of the CI remains active in this case to ensure the CI's wake up functionality. The CI therefore still requires a power cord.

4 Operation

The C1 D/A controller is operated from the front panel, from the IR remote control or from CH Precision's Android app. Feedback to the user is provided by a high-definition display with customizable colors. Setup operations are handled from the front panel or the CH Control Android app.

4.1 Front panel controls

4.1.1 Front panel

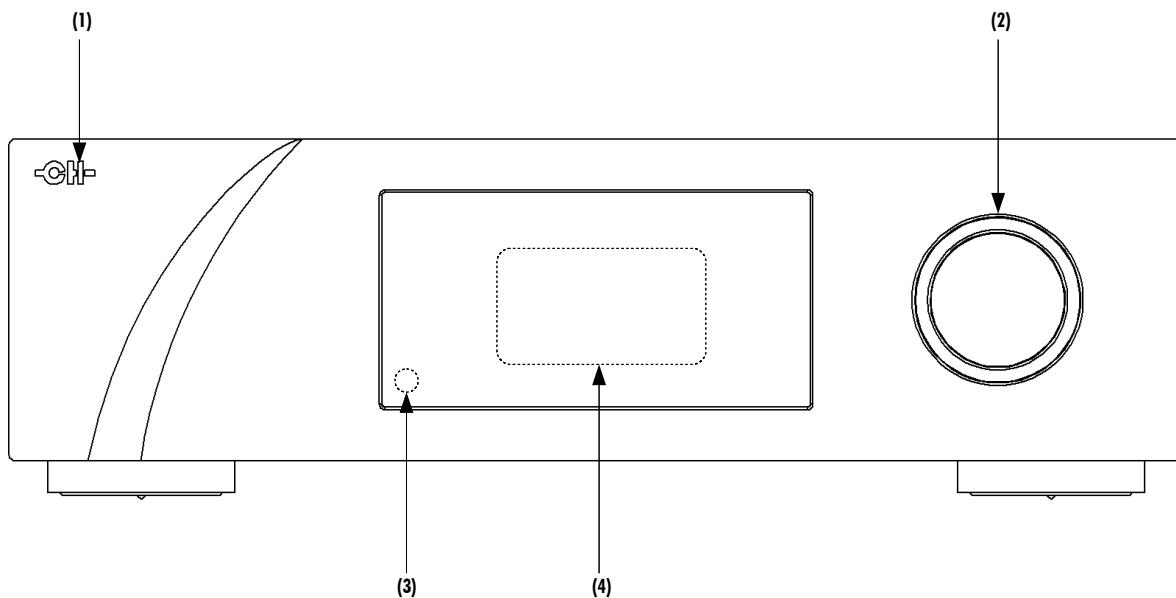

Front panel elements

- (1) Standby LED
- (2) User control knob (dual concentric rotatory knob with push function)
- (3) IR remote control receiver
- (4) Display area (high-definition AMOLED display)

The standby LED lights up when the unit is in standby. It is normally turned-off during operation and shortly lights up whenever it receives a valid IR remote control command. The LED can also be programmed to remain on during operation. The display is a high-definition 24 bit RGB panel with very wide viewing angle, high contrast and high brightness ensuring optimal reading comfort. The color and brightness of the display can be configured according to user's taste and different colors can be chosen for PCM, DSD or analog input playback.

4.1.2 User control knob

The user control knob is the main user input device. It is built around a dual concentric rotatory knob with push function, mounted on a Teflon guide. Both the central and the external part of the knob can be moved to the left (counter-clockwise) or the right (clockwise) independently, giving four movements: External Rotate Left/Right [$\llbracket E \rrbracket / \llbracket E \gg \rrbracket$] and Central Rotate Left/Right [$\llbracket C \rrbracket / \llbracket C \gg \rrbracket$]. The central part of the knob also supports a push functionality. There are two types of push: Normal Push [NP] and



Long Push [LP]. For a Normal Push, just press the central part of the knob and release it immediately. For a Long Push, press and hold the central part of the knob for 2s or more.

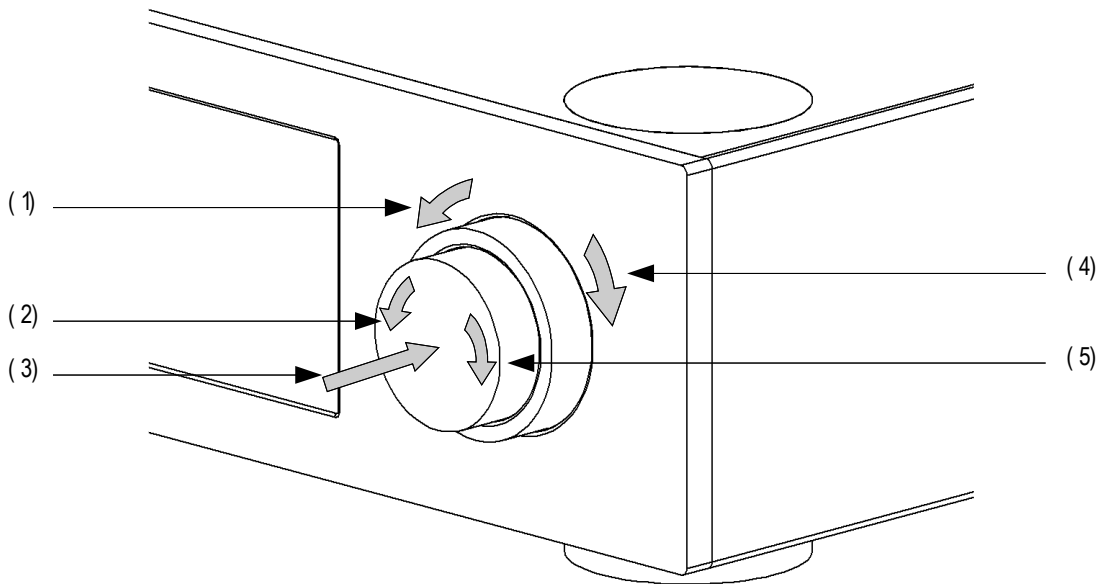

User control knob movements

- (1) External ring rotate Left [<<E]
- (2) Central knob rotate Left [<<C]
- (3) Central knob push. There are two types of push: Normal Push [NP] and Long Push [LP]
- (4) External ring rotate Right [E>>]
- (5) Central knob rotate Right [C>>]

| User Action Code | Description |
|------------------|---|
| [<<C] | Central Left: Rotate central knob to the left |
| [C>>] | Central Right: Rotate central knob to the right |
| [<<E] | External Left: Rotate external ring to the left |
| [E>>] | External Right: Rotate external ring to the right |
| [NP] | Normal Push: push and release central knob |
| [LP] | Long Push: push central knob and maintain for 2s before release |

User Action Codes

4.2 Operating modes

The CI D/A controller has two main operating modes: Normal mode and Menu mode. Normal mode is used to access standard preamplifier controls whereas Menu mode is used to configure the unit. The CI also includes Shortcuts for quick access to selected Menu mode items. Shortcuts are user programmable and most Menu mode items can be selected as Shortcuts.

4.2.1 Normal mode

Normal mode is used for standard preamplifier functions. When powered-on, the CI starts in Normal mode. The display looks as follows:



Normal mode display elements

- (1) Incoming audio sampling frequency (first number) and DSP output frequency (either 705.6 or 768 kHz) feeding conversion chips. Shows the upsampling (or DSD to PCM conversion) performed by the CI's PEtER algorithm.
- (2) Mute indication. If the symbol is present, the output is muted
- (3) Analog output level. Only displayed when CI is used as a preamplifier. When CI is used as a pure DAC (selectable through CI's menu), output level is set to 0 dB and not mentioned in this display area.
- (4) Analog audio output signal polarity (phase) indication. If the Φ symbol is present, polarity is reversed
- (5) External power supply indication. When an external power supply is connected and engaged, symbol is displayed and internal power supply is turned off
- (6) Clock source indication (internal, audio in, or clock frequency when an external clock is selected as the clock source)
- (7) Lock indication (or). Tells if the unit is locked to a clock source or not
- (8) Input source name. Each input source can be renamed through CI's menu

Displayed elements depend on the installed optional boards and user settings. In the example above, CI is playing the audio coming from its first AES-EBU input at the rate of 44.1 kHz, upsampling it to 705.6 kHz (x16). The output level is -18.5 dB, but is currently muted. CI has locked its 22.5792 MHz (512 x 44.1 kHz) VCXO to the incoming audio stream. The polarity of the audio



signal is inverted, and the CI is powered by an X1 external DC power supply. Displayed elements for other configurations are similar.

Following table shows the actions of the user control knob in Normal mode.

| User Control Knob Action | Unit State | Unit Action |
|-----------------------------|---|---|
| [NP] Normal Push | STANDBY Any other state | Wake from STANDBY Enter Shortcuts mode |
| [LP] Long Push | STANDBY Any other state | Wake from STANDBY Go to STANDBY |
| [C>>] Center Rotate Right | D/A Controller (preamplifier) D/A Converter (pure DAC) | Increase volume (1 st by 0.5 dB steps, then faster) Select next available input |
| [<<C] Center Rotate Left | D/A Controller (preamplifier) D/A Converter (pure DAC) | Decrease volume (1 st by 0.5 dB steps, then faster) Select previous available input |
| [E>>] External Rotate Right | Any state | Select next available input |
| [<<E] External Rotate Left | Any state | Select previous available input |

User control knob actions in Normal mode

4.2.2 Shortcuts

The CI D/A controller is configured by a set of menus as described in the next sections. To allow quick access to the most frequently used configuration menu items, the CI offers the concept of Shortcuts. Shortcuts are fully programmable and the user may choose any configuration parameter as a Shortcut. There are up to 6 user programmable Shortcuts. To learn how to program individual Shortcuts, please refer to the SHORTCUTS menu item in the next section.

Shortcuts are accessed from Normal mode by a Normal Push [NP]. Additional Normal Push [NP] skips to the next Shortcut. The last Shortcut is always dedicated to entering the Menu mode (SETUP). On this last Shortcut, a Normal Push [NP] will return to Normal Mode and an External Rotate Right [E>>] (or Central Rotate Right [C>>]) will enter the Menu mode. The individual parameter for a given Shortcut is modified using External Rotate Left [<<E] (or Central Rotate Left [<<C]) and/or External Rotate Right [E>>] (or Central Rotate Right [C>>]). If there is no user action for about 10s the unit will revert to Normal mode.

Following table shows the actions of the user control knob for Shortcuts.

| User Control Knob Action | Unit State | Unit Action |
|----------------------------|---|--|
| [NP] Normal Push | Shortcut (except last) Last Shortcut (SETUP) or after current Shortcut has been modified | Skip to next Shortcut Exit Shortcuts mode (Normal mode) |
| [LP] Long Push | Any state | As in Normal mode |
| [C>>] Central Rotate Right | Shortcuts (except last) Last Shortcut (SETUP) | Modify parameter up (when available) Enter Menu mode |
| [<<C] Central Rotate Left | Shortcuts | Modify parameter down (when available) |

| | | |
|-----------------------------|--|---|
| [E>>] External Rotate Right | Shortcuts (except last) Last Shortcut (SETUP) | Modify parameter up (when available) Enter Menu mode |
| [<<E] External Rotate Left | Shortcuts | Modify parameter down (when available) |

User control knob actions for Shortcuts

The PHASE POLARITY Shortcut gives a good illustration of how to navigate a Shortcut screen. Navigating other Shortcuts is similar.

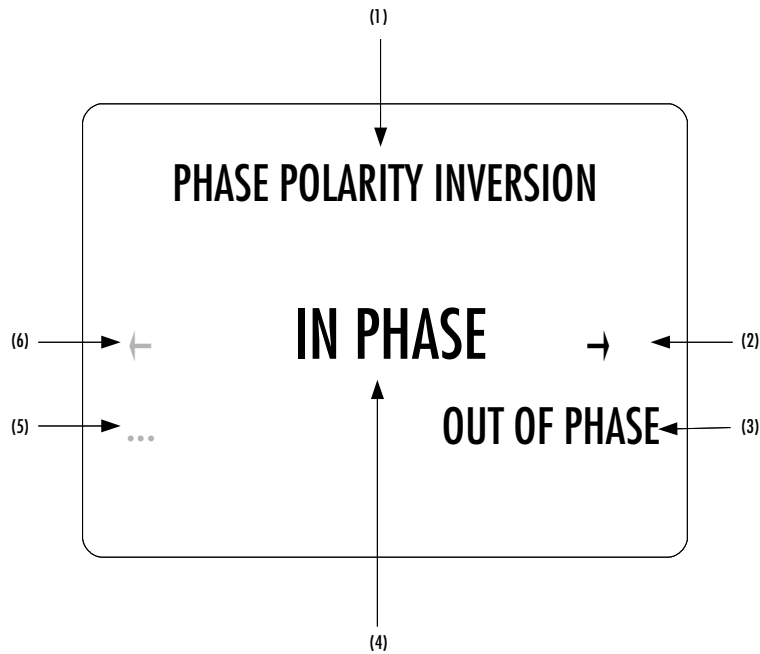

PHASE POLARITY Shortcut display elements

- (1) Shortcut title (Parameter, for other Shortcuts, title changes accordingly)
- (2) Arrow indicating External Rotate Right [E>>] if applies. The item below indicates the next parameter value (up direction)
- (3) Next Parameter Value if External Rotate Right [E>>] is applied (parameter up)
- (4) Current Parameter Value (for other Shortcuts the current Value of the Parameter is displayed on this line)
- (5) Next parameter value if External Rotate Left [<<E] is applied (parameter down)
- (6) Arrow indicating External Rotate Left [<<E] if applies. The item below indicates the next parameter value (down direction)

The last Shortcut (SETUP) is always the same and cannot be removed or altered. It gives access the Menu mode to access the detailed setup of the unit.

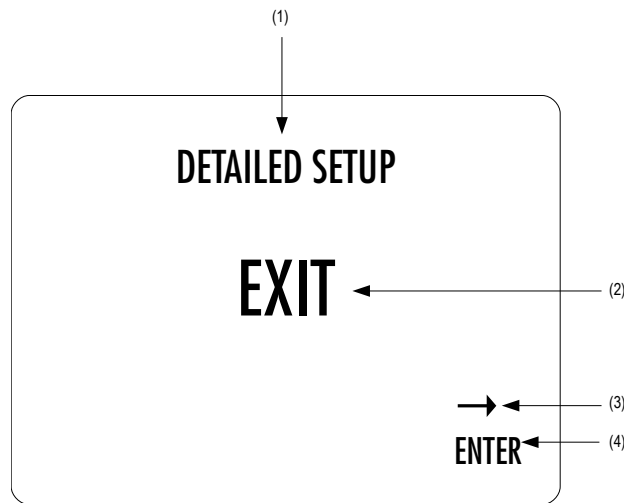

SETUP Shortcut display elements

- (1) Shortcut title. It indicates that Detailed Setup (Menu mode) can be entered at this stage
- (2) Current value of the parameter. Default action is to exit (go back to Normal mode)
- (3) Arrow indicating External Rotate Right [E>>] (or Central Rotate Right [C>>])
- (4) Next parameter value. If External Rotate Right [E>>] is applied, the unit enters into Menu mode

4.2.3 Menu mode

The Menu mode allows for Configuration and Setup of the CI D/A controller through a set of menus. Menu mode is entered from the last Shortcut item (see above). From Normal mode, enter the Shortcut mode by applying a Normal Push [NP]. By successive Normal Pushes [NP], step to the last Shortcut item (DETAILED SETUP) and apply an External Rotate Right [E>>] to enter the Menu mode.

Navigation in Menu mode is based on Central Rotate Left/Right [<<C]/[C>>] to select a given menu item and External Rotate Left/Right [<<E]/[E>>] to change menu level.

| User Control Knob Action | Unit Action |
|-----------------------------|---|
| [NP] Normal Push | Enter next menu level or Validate choice (save setting) |
| [LP] Long Push | Puts the unit into Standby |
| [C>>] Center Rotate Right | Move to next menu item downward |
| <<<C] Center Rotate Left | Move to next menu item upward |
| [E>>] External Rotate Right | Enter next menu level |
| <<<E] External Rotate Left | Return to previous menu level without saving |

User control knob actions in Menu mode

Following illustration shows the elements of a the C1 SETUP Menu page, the entry point to the C1 menu structure.

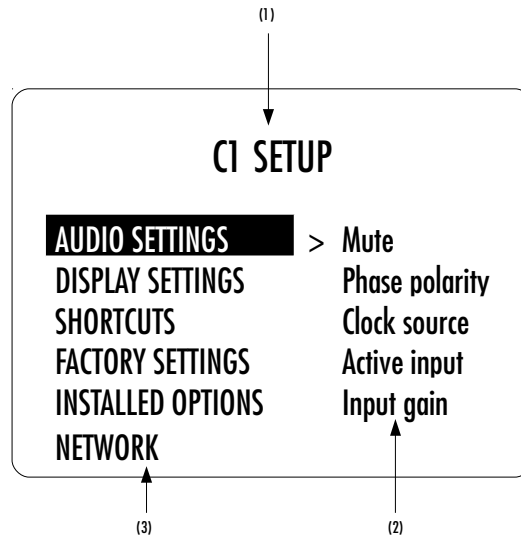

C1 SETUP menu display elements

- (1) Menu title. When entering a menu item, the title also shows the parent menu. If the AUDIO SETTINGS menu is entered, the title line would display C1 SETUP >> AUDIO SETTINGS.
- (2) Shows the accessible parameters when entering the currently highlighted menu item. In this example, AUDIO SETTINGS is highlighted and the second column shows the parameters accessible in the AUDIO SETTINGS menu.
- (3) List of items in the current menu. Navigate from one item to the other using Central Rotate Left/Right [C]/[C]. To enter the highlighted menu item, use External Rotate Right [E>>] (or a Normal Push [NP]). To go to the previous menu level use External Rotate Left [E]. In this example, External Rotate Left [E] exits the Menu mode and sets the unit back to Normal mode.

Once a menu item is selected by External Rotate Right [E>>], parameters for the corresponding menu item can be navigated and accessed. As an example, the following drawing shows the display elements of the C1 SETUP >> AUDIO SETTINGS sub-menu.

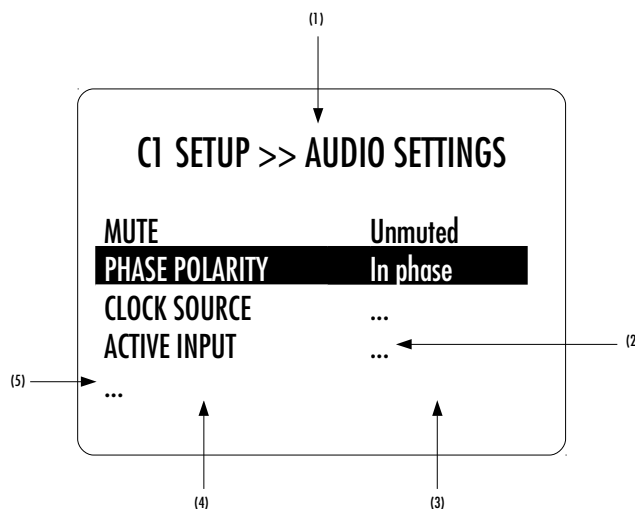

C1 SETUP >> AUDIO SETTINGS menu display elements

- (1) Menu title. CI SETUP >> AUDIO SETTINGS shows that the parent menu is CI SETUP. By applying External Rotate Left [<<E], the unit returns to the parent menu.
- (2) A Parameter Value of '...' indicates that the menu items gives access to one or more further sub-menu(s). Further sub-menus have the same structure as this example.
- (3) This is the Parameter Value column. For each item in the Parameter column, the Parameter Value item on the same line indicates the current value of the Parameter.
- (4) This is the Parameter column. The currently active Parameter is highlighted. Use Central Rotate Left/Right [<<C]/[C>>] to navigate from Parameter to Parameter.
- (5) If the first or last item in the Parameter column is indicated by '...' it means that there are additional Parameters not displayed currently on-screen. Use Central Rotate Left/Right [<<C]/[C>>] to navigate towards the '...' to make the corresponding Parameters appear on screen.

Once a terminal Parameter (e.g. a Parameter not giving access to a further sub-menu) is selected by External Rotate Right [E>>], the CI displays the corresponding Parameter adjustment screen. Following example shows the AUDIO SETTINGS >> PHASE POLARITY Parameter adjustment screen. Other Parameters are similar but may show more (or less) choices for Parameter value. Once a Parameter is set to the desired value, a Normal Push [NP] saves the new Parameter Value and gets back to the parent level (save and exit). On the other hand, an External Rotate Left [<<E] gets back to the parent menu (in the case of this example: AUDIO SETTINGS), but possible modifications of the Parameter Value are discarded (exit without saving).

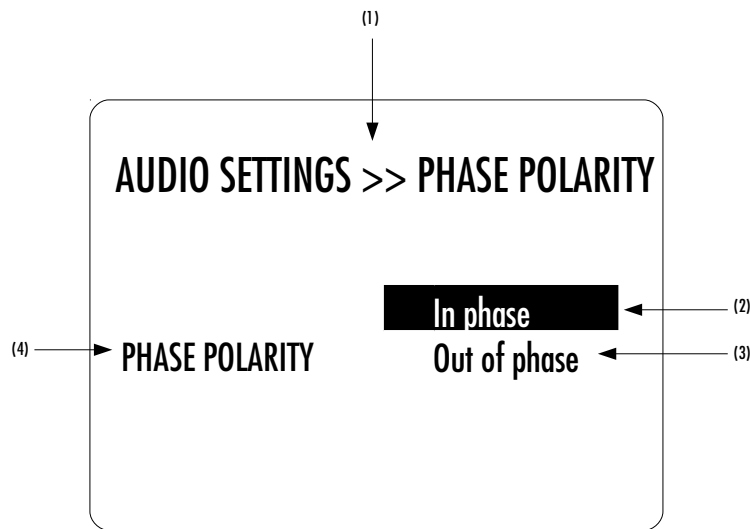

AUDIO SETTINGS >> PHASE POLARITY menu display elements

- (1) Menu title. AUDIO SETTINGS >> PHASE POLARITY shows that the parent menu is AUDIO SETTINGS. To access the parent menu, use External Rotate Left [<<E]
- (2) The current Parameter Value is highlighted. Use Central Rotate Left/Right [<<C]/[C>>] to navigate through Parameter Values
- (3) Other possible Parameter Value(s). Number of other Parameter Value(s) depends on Parameter
- (4) Parameter for which the Parameter Value can be modified in the current menu.

The following section gives detailed information about the menu structure and the various Parameters. Note that certain Parameter may or may not appear in the menu depending on installed options. For instance if no ANALOG_IN board is installed, menu items related to the RCA and XLR inputs (enable, gain, renaming) do not appear in the menu.

4.3 Configuration

Configuration of your CI D/A controller is accomplished by setting parameters in the Menu mode (see previous section for how to access Menu mode and how to navigate menu items). Following diagram shows the complete menu structure (terminal items not show). Grayed menu items are items which depend on installed optional slot-in boards.

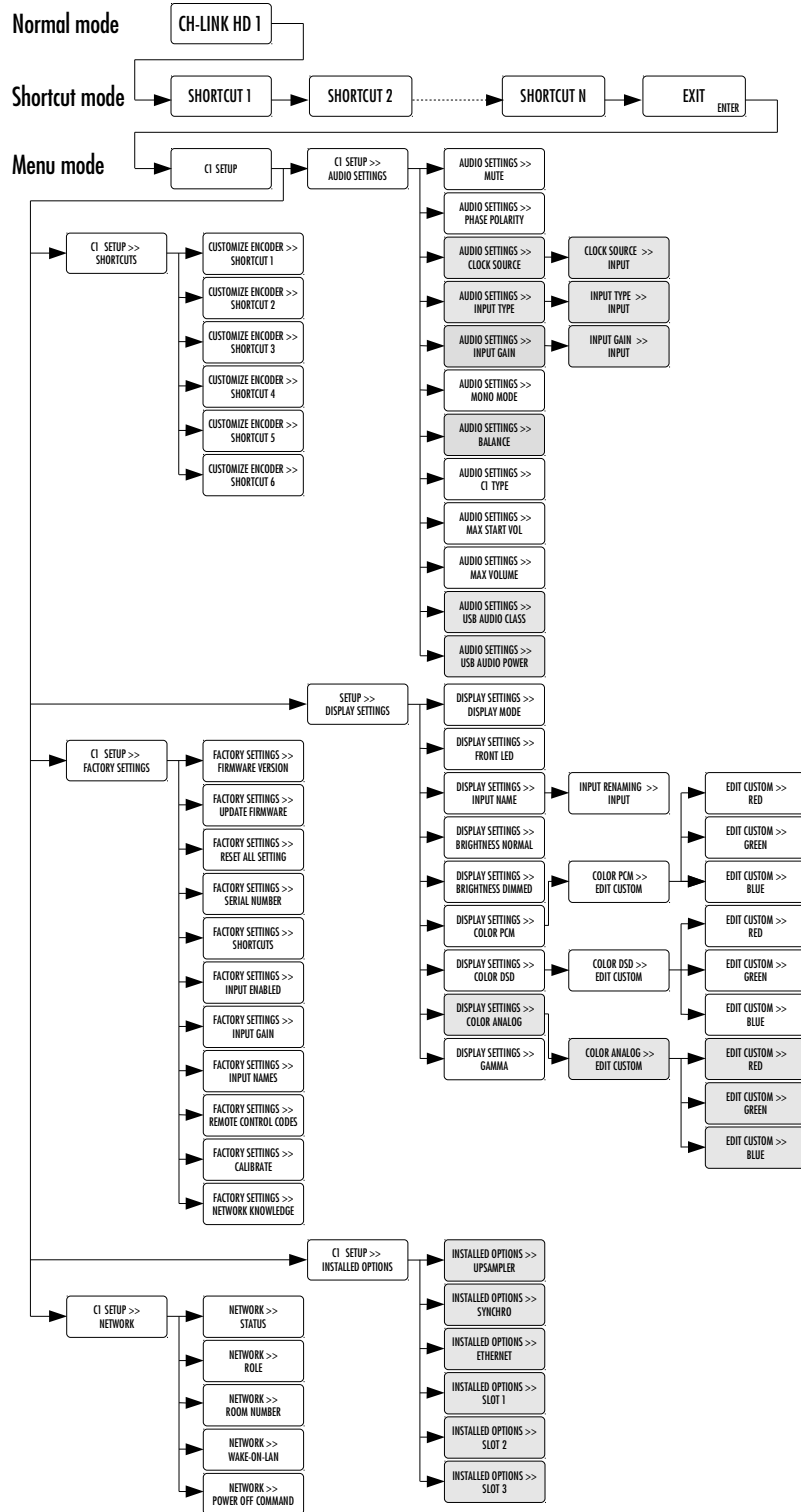

CI D/A controller menu structure



There are six main menus used for configuration of the C1 :

- **AUDIO SETTINGS:** Allows to adjust audio related parameters
- **DISPLAY SETTINGS:** Allows to adjust display related parameters
- **SHORTCUTS:** Allows to assign and modify Shortcuts for user interface customization
- **FACTORY SETTINGS:** Indicates the software version and allows to update it. Also allows to return to factory settings and calibrate the C1
- **INSTALLED OPTIONS:** Provides information about the installed optional slot-in boards
- **NETWORK:** Provides information about the network setup and enables its configuration

4.3.1 C1 configuration menu items

4.3.1.1 AUDIO SETTINGS

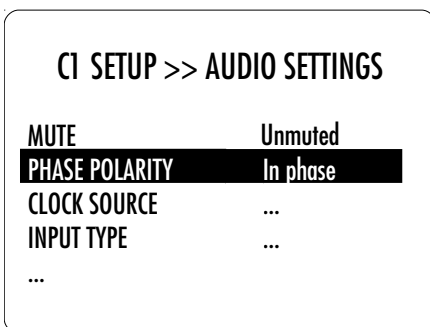

The C1 SETUP >> AUDIO SETTINGS menu allows configuration of the audio related Parameters of the unit. Accessible Parameters are:

- **MUTE:** Mutes or unmutes the audio output
- **PHASE POLARITY:** Allows to revert the phase of the audio output
- **CLOCK SOURCE:** Allows to select the clock source for each input
- **INPUT TYPE:** Selects if an input is hidden, and/or volume controlled.
- **INPUT GAIN:** Sets individual gain/attenuation per input
- **MONO MODE:** Allows to route left (resp. right) input to both outputs
- **BALANCE:** +/-6dB L/R balance correction
- **C1 TYPE:** Enables volume control
- **MAX START VOL:** Sets maximum allowed volume at startup in controller mode
- **MAX VOLUME:** Sets maximum allowed volume in controller mode
- **USB AUDIO CLASS:** Select class 1.0 (96/24 max) or class 2.0 (192/24 max)
- **USB AUDIO POWER:** Allows USB audio section power off when unused

The following table details the Parameters of the AUDIO SETTINGS menu:

| PARAMETER | PARAMETER VALUES | REQUIRED OPTIONS | REMARKS |
|----------------|------------------|------------------|---------|
| MUTE | Muted Unmuted | None | None |
| PHASE POLARITY | In phase | None | None |



| | | | |
|--|---|---|---|
| | Out of phase | | |
| CLOCK SOURCE (individually selectable for each input) | Audio In Internal Clock Synchro BNC (75 Ohm) Synchro BNC (Hi-Z) SRC | SYNC_IO board to choose some of these clock sources | <p>Audio In clock source is available in all cases for digital in board inputs.</p> <p>SRC adds an asynchronous sample rate converter stage that allows the CI to lock even on S/PDIF sources that do not comply with AES requirements.</p> <p>Internal Clock is the default choice for computer sources (USB audio and Ethernet streaming) where CI is the clock master.</p> <p>Synchro BNC (75 Ohm) and Synchro (Hi-Z) are only available when the SYNC_IO board is installed. Select Synchro BNC 75 Ohm as the clock source for CH-link HD, USB, Ethernet, and Roon Ready inputs when using the T1 as the master clock.</p> <p>SYNC_IO offers choice of 75 Ohm or high-impedance on its BNC clock input.</p> |
| INPUT TYPE | Disabled Normal Processor | | <p>“Disabled” inputs cannot be selected anymore when scrolling through inputs (with remote control or encoder).</p> <p>For “Processor” inputs, the CI 's volume control (in processor mode) is not applied (no attenuation!)</p> <p>Only available inputs (depends on hardware configuration) can be enabled/disabled in the menu</p> |
| INPUT GAIN (individually selectable for each input) | -6 dB to +6 dB by 0.5 dB steps | None | None |
| MONO MODE | Stereo Mono Left Mono Right | None | When “Mono Left” (respectively “Mono Right”) is selected, the left (respectively right) audio input is mapped to bot CI 's outputs |
| BALANCE | Left +6 dB to Right +6 dB by 0.5 dB steps | None | None |
| CI TYPE | D/A Controller D/A Converter | Connected to power amp Connected to preamp | When CI is configured as D/A Converter, its output volume is not attenuated (0dB). This setting should only be selected if CI is used with an external preamplifier (or integrated amplifier) |
| MAX START VOL | -50 dB to -20 dB by 10 dB steps | None | <p>The startup volume is the lowest of the following:</p> <ul style="list-style-type: none"> - Last listening volume before standby - MAX START VOL parameter value |



| | | | |
|-----------------|--|----------------|--|
| MAX VOLUME | -30 dB to 0 dB by 10 dB steps, or no limitation (up to +24 dB) | None | Limits the output volume of the CI in controller mode |
| USB AUDIO CLASS | 1.0 or 2.0 | USB_IN #1 / #2 | More detail in chapter 3.3.4 USB_IN boards |
| USB AUDIO POWER | Auto shutdown or Keep USB powered | USB_IN #1 / #2 | Auto shutdown allows automatic power off of the USB audio board (including its DSP) when another input is selected to minimize noise. In that case, the computer loses connection to the CI and its playback will stop as another input is selected. Keep USB powered allows quick switching from another input to the USB audio input, as it keeps processing when another input is selected in the CI. |

Details of AUDIO SETTINGS menu Parameters

4.3.1.2 DISPLAY SETTINGS

| CI SETUP >> DISPLAY SETTINGS | |
|------------------------------|--------|
| DISPLAY MODE | Status |
| FRONT LED | Off |
| INPUT NAME | ... |
| BRIGHTNESS NORMAL | 60 % |
| ... | |

The CI SETUP >> DISPLAY SETTINGS menu allows configuration of the display related Parameters of the unit. Accessible Parameters are:

- DISPLAY MODE: Allows to choose what to display
- FRONT LED: Selects if the front LED remains on when CI is on
- INPUT NAME: To customize the name of any input
- BRIGHTNESS NORMAL: Sets the normal display brightness
- BRIGHTNESS DIMMED: Sets the dimmed display brightness
- COLOR PCM: Selects the display color for PCM playback
- COLOR DSD: Selects the display color for DSD playback
- COLOR ANALOG: Selects the display color for analog source playback
- GAMMA: Fine tunes the AMOLED's display RGB gamma curve

The following table details the Parameters of the DISPLAY SETTINGS menu:

| PARAMETER | PARAMETER VALUES | REQUIRED OPTIONS | REMARKS |
|-------------------|-------------------------|------------------|--|
| DISPLAY MODE | Status Volume Off | None | Selects what to display when the unit is idle for several seconds: General status page, CI's volume or turn off the display. |
| FRONT LED | On Off | None | Allows to keep the LED on when the unit is on. |
| INPUT NAME | <i>Any string</i> | None | Used to rename any input in the CI |
| BRIGHTNESS NORMAL | 10% ... 100% | None | Sets the display brightness when the unit is operated in 10% steps. |



| | | | |
|-------------------|--|--------------------------|--|
| BRIGHTNESS DIMMED | 10% 20% 30% | None | Sets the display brightness when the unit is left idle for several seconds. |
| COLOR PCM | <i>Predefined colors</i> Custom color Edit custom color | None | Selects the display color for PCM playback <i>Predefined colors</i> represents a set of factory defined colors Custom color is a user definable color. To Edit the custom color select the Edit custom color Value. Sub-menus allow to individually configure Red, Green and Blue components (RGB) of the custom color. |
| COLOR DSD | <i>Predefined colors</i> Custom color Edit custom color | None | Selects the display color for DSD playback <i>Predefined colors</i> represents a set of factory defined colors Custom color is a user definable color. To Edit the custom color select the Edit custom color Value. Sub-menus allow to individually configure Red, Green and Blue components (RGB) of the custom color. |
| COLOR ANALOG | <i>Predefined colors</i> Custom color Edit custom color | ANALOG_IN or PHONO_IN | Selects the display color for analog input playback <i>Predefined colors</i> represents a set of factory defined colors Custom color is a user definable color. To Edit the custom color select the Edit custom color Value. Sub-menus allow to individually configure Red, Green and Blue components (RGB) of the custom color. |
| GAMMA | RBG and global brightness gamma curve correction, +/-30% | None | Fine adjustment the gamma scale of the RGB components of the display. Allows to have perfectly dark background and to match other CH Precision unit's display color, even at low brightness. |

Details of DISPLAY SETTINGS menu Parameters

4.3.1.3 SHORTCUTS

The CI SETUP >> SHORTCUTS menu allows configuration of the Shortcuts.

Accessible Parameters are:

- SHORTCUT1 : Defines action for Shortcut #1

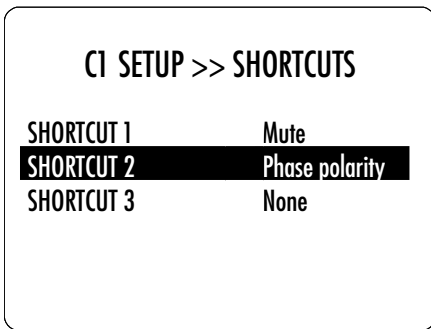

...
 - SHORTCUT6: Defines action for Shortcut #6
 Note that unused Shortcuts are not displayed. The first available (e.g. non defined) Shortcut has a Parameter Value of 'None' (the example on the left has 4 defined Shortcuts, hence Shortcut #5 has a Parameter Value of 'None')

The following table details the Parameters of the SHORTCUTS menu:

| PARAMETER | PARAMETER VALUES | REQUIRED OPTIONS | REMARKS |
|------------|---|------------------|---|
| SHORTCUT 1 | Most Parameter of the AUDIO SETTINGS and DISPLAY SETTINGS menus or None | None | If SHORTCUT 1 is not defined, Parameter value for SHORTCUT 1 is set to 'None'. SHORTCUT 2 to 6 are not displayed in this case. |
| SHORTCUT 2 | Most Parameter of the AUDIO SETTINGS and DISPLAY SETTINGS menus or None | None | If SHORTCUT 2 is not defined, Parameter value for SHORTCUT 2 is set to 'None'. SHORTCUT 3 to 6 are not displayed in this case. |
| SHORTCUT 3 | Most Parameter of the AUDIO SETTING Sand DISPLAY SETTINGS menus or None | None | If SHORTCUT 3 is not defined, Parameter value for SHORTCUT 3 is set to 'None'. SHORTCUT 4 to 6 are not displayed in this case. |
| SHORTCUT 4 | Most Parameter of the AUDIO SETTINGS and DISPLAY SETTINGS menus or None | None | If SHORTCUT 4 is not defined, Parameter value for SHORTCUT 4 is set to 'None'. SHORTCUT 5 and 6 are not displayed in this case. |
| SHORTCUT 5 | Most Parameter of the AUDIO SETTINGS and DISPLAY SETTINGS menus or None | None | If SHORTCUT 5 is not defined, Parameter value for SHORTCUT 5 is set to 'None'. SHORTCUT 6 is not displayed in this case. |
| SHORTCUT 6 | Most Parameter of the AUDIO SETTINGS and DISPLAY SETTINGS menus or None | None | If SHORTCUT 6 is not defined, Parameter value for SHORTCUT 6 is set to 'None'. |

Details of SHORTCUTS menu Parameters

4.3.1.4 FACTORY SETTINGS

The CI SETUP >> FACTORY SETTINGS menu allows to get information about current CI firmware version, to update the CI firmware, to reset the unit to default configuration (or subset of settings), and to calibrate the DAC stage. Accessible Parameters are:

- FIRMWARE VERSION: Current firmware version (read only)



CI SETUP >> FACTORY SETTINGS

| | |
|------------------------|-----------------|
| FIRMWARE VERSION | 1.3 |
| UPDATE FIRMWARE | Update |
| RESET ALL SETTINGS | Reset |
| SHORTCUTS | Default mapping |
| ... | |

- UPDATE FIRMWARE: Allows to update the unit's firmware
- RESET ALL SETTINGS: Returns the unit to factory settings
- SERIAL NUMBER: Displays the serial number of the machine
- SHORTCUTS: Redefines all Shortcuts to factory settings
- INPUT ENABLED: Allows to enable all digital inputs at once
- INPUT GAIN: Reset all input gain to 0 dB
- INPUT NAMES: Put back default name to all inputs
- REMOTE CONTROL: Select to which set of RC5 commands the CI responds
- CALIBRATE: Run auto-calibration process
- NETWORK KNOWLEDGE: Clears list of detected devices on network

The following table details the Parameters of the FACTORY SETTINGS menu:

| PARAMETER | RELATED ACTION/VALUE | REQUIRED OPTIONS | REMARKS |
|--------------------|------------------------------|------------------------|---|
| FIRMWARE VERSION | <i>Firmware version</i> | None | <i>Firmware version</i> indicates the version of the current firmware. Format is <i>x.y</i> . This parameter is read only. |
| UPDATE FIRMWARE | Update | None | Selecting 'Update' launches the CI firmware update process. A USB flash disc drive with a valid set of firmware must be inserted in the A-shaped USB port |
| RESET ALL SETTINGS | Reset | None | Selecting 'Reset' returns the CI to its factory settings. Factory settings are detailed in the Specifications section. |
| SERIAL NUMBER | <i>Serial number</i> | None | <i>Serial number</i> indicates the serial number of the CI. Format is <i>yymm02nn</i> . This parameter is read only. |
| SHORTCUTS | Default mapping | None | Selecting 'Default Mapping' returns the CI's Shortcuts to their factory settings. Factory settings are detailed in the Specifications section. |
| INPUT ENABLE | Enable all | None | Selecting 'Enable all' will enable all available CI inputs. |
| INPUT GAIN | Set default gain | None | Set back the gain/attenuation of all inputs to 0dB. |
| INPUT NAMES | Default names | None | Set back all input names to their default value |
| REMOTE CONTROL | None RC5 Pre1 RC5 Pre2 | None | Selects to which set of RC5 commands the CI will respond to. Pre1 is the standard RC5 Preamplifier set, Pre2 is an alternate RC5 Preamplifier set (it corresponds to the set of commands the CI remote control sends by default). When 'None' is selected, the CI cannot be controlled by a remote control anymore. |
| CALIBRATE | Start calibration | CI should be warmed-up | Launch automated calibration left and right channel DAC stage. It takes about 40s per channel to complete. For optimal performances, please make |



| | | | |
|-------------------|-------|------|---|
| | | | sure the CI is warmed-up (i.e. turned on for more than an hour) before running calibration. |
| NETWORK KNOWLEDGE | Reset | None | Clears the CI 's memory of other CH Precision devices it has discovered through the TCP/UDP proprietary protocol. |

Details of FACTORY SETTINGS menu Parameters

4.3.1.5 INSTALLED OPTIONS

| CI SETUP >> INSTALLED OPTIONS | |
|-------------------------------|---------------------|
| UPSAMPLER | Spline |
| SYNCHRO | Clock In/Out |
| ETHERNET | Control |
| SLOT 1 | Digital In 1 |
| SLOT 2 | USB In 1 |
| SLOT 3 | - |

The CI SETUP >> OPTIONS menu provides read-only information about installed slot-in boards. Details are:

- UPSAMPLER: Type of upsampler
- SYNCHRO: Synchronization option installed
- ETHERNET: Board type in the Ethernet slot: CONTROL (default) or ETHERNET_HD (streaming option)
- SLOT 1: Input board installed in Slot 1
- SLOT 2: Input board installed in Slot 2
- SLOT 3: Input board installed in Slot 3

Each slot indicates the type of board it handles. A '-' indicates that the slot is currently unpopulated.

The following table details the Parameters of the INSTALLED OPTIONS menu:

| PARAMETER | PARAMETER VALUES | REQUIRED OPTIONS | REMARKS |
|----------------------------|---|------------------------------------|--|
| UPSAMPLER | Spline | DIGITAL_IN_HD board | Reports that the upsampling algorithm is the new CH-PeTER spline interpolator |
| SYNCHRO | Clock In/Out - | SYNC_IO board - | Reports the presence of the SYNC_IO board in the corresponding slot. |
| ETHERNET | Control Streaming | CONTROL board ETHERNET_HD board | Reflect which board type populates the Ethernet slot. |
| SLOT 1 SLOT 2 SLOT 3 | Digital In HD 1/2/3 USB In 1/2 Analog In 1/2 Phono MC 1/2 - | Min. 1x DIGITAL_IN_HD | Parameter report which type of boards are installed in the different slots. '-' indicates that no board is installed in the given slot. Parameters are Read Only |

Details of INSTALLED OPTIONS menu Parameters



4.3.1.6 NETWORK

| C1 SETUP >> NETWORK | |
|---------------------|--------------------|
| STATUS | 1 device connected |
| ROLE | Master |
| ROOM NUMBER | 1 |
| IP SETTINGS | Auto (DHCP) |
| WAKE-ON-LAN | Only if PoE |
| POWER OFF COMMAND | Yes |

The C1 SETUP >> NETWORK menu allows knowledge and customization of the network related Parameters of the unit. Accessible Parameters are:

- STATUS: Listing of all CH products detected (product type, IP and MAC addresses)
- ROLE: Defines how the C1 interacts with other devices on the network
- ROOM NUMBER: Group units connected to a single network by room
- IP SETTINGS: Low-level network configuration
- WAKE-ON-LAN: Select if a unit can be powered on from the network
- POWER OFF COMMAND: Selects if the C1 can be turned off by a network command

The following table details the Parameters of the NETWORK menu:

| PARAMETER | PARAMETER VALUES | REQUIRED OPTIONS | REMARKS |
|-------------|--|--|--|
| STATUS | IP address Product type MAC address | Connection to a router via its RJ-45 Ethernet port | List of CH Precision devices and Android remote controls detected by the C1 (product type, IP and MAC addresses) Read Only parameters |
| ROLE | Offline Power master Master Slave Custom | Connection to a router via its RJ-45 Ethernet port (on the Control board). | When physically connected to a network, the C1 can ignore this network (offline) or connect to it as being the master (it will transmit IR received commands to all slave) or as a slave (it will ignore remote control commands and receive commands from the master device). This networking facility allows information sharing among CH products (such as sound level for multichannel configurations). |
| ROOM NUMBER | 1 ... 7 | Connection to a router via its RJ-45 Ethernet port | Define the room in which room the C1 is for multiroom applications. This prevents CH Precision units connected to the same network but located in different systems/rooms to interact with each others. |
| IP SETTINGS | Auto (DHCP) Direct-Link Manual | Connection to a router via its RJ-45 Ethernet port | Auto should be selected if the C1 is connected to a router with DHCP server feature. |
| WAKE-ON-LAN | No Only if PoE | Connection to a router via its RJ-45 Ethernet | If No is selected, the C1 can't be woken up by the app. Standby mode will consume less than 0.5W. |

| | | | |
|-------------------|-----------|--|--|
| | Yes | port | When Only if PoE is selected, the C1 can only be woken by the app if connected to a Power-over-Ethernet switch. Standby mode will draw less than 0.5W from the mains plug. NOTE: it is not necessary to connect the C1 to a POE port using the Ethernet_HD board. If Yes is selected, the C1 can always be woken up by the app. Standby mode will draw a couple of watts from the mains plug. |
| POWER OFF COMMAND | Yes No | Connection to a router via its RJ-45 Ethernet port | If no is selected, the C1 will ignore any power off command it may receive from the network. |

Details of NETWORK menu Parameters

4.4 Remote control

4.4.1 Remote control operation

The C1 controller is delivered with an IR remote to control the unit's basic operations. The provided remote control is not intended to be used to configure the unit.

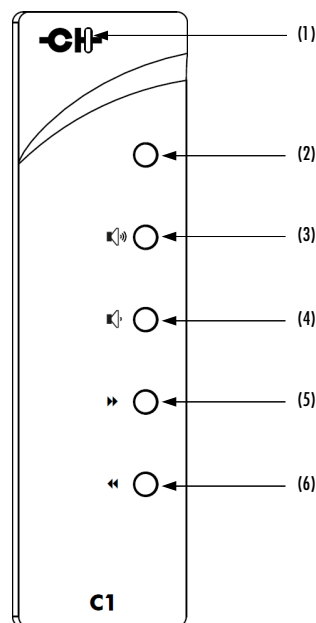

C1 D/A Controller remote control

- (1) Remote control activity LED
- (2) Mute/Standby (long push) button
- (3) Volume up button
- (4) Volume down button
- (5) Next input button / Phase polarity inversion (long push)
- (6) Previous input button / Phase polarity inversion (long push)



The remote control activity LED is illuminated while a button is pushed on the remote. The remote control buttons support dual functions by distinguishing Normal Push [NP] and Long Push [LP]. For a Normal Push [NP], the button is released immediately after pressing. A Long Push [NP] requires the button to be pressed for at least 2s before being released.

Remote control functions are according to the following table:

| Remote Control Button | Normal Push [NP] | Long Push [LP] |
|-----------------------|--|---------------------------------------|
| MUTE | Mute/Unmute (also wakes-up from STANDBY) | Sets unit into STANDBY or wakes it up |
| VOLUME UP | +0.5 dB | Increase volume by larger steps |
| VOLUME DOWN | -0.5 dB | Decrease volume by larger steps |
| NEXT INPUT (▶) | Select next enabled input | Phase inversion |
| PREVIOUS INPUT (◀) | Select previous enabled input | Phase inversion |

Remote control functions

4.4.2 Changing the remote control batteries

If the LED does not turn on when pressing a button of the remote, it is likely that the remote batteries need to be changed. To replace the batteries, remove the back cover of the remote control by removing the screws (M2.5 cross-shaped type, make sure to use appropriate screwdriver). Exchange the batteries for new ones (make sure to respect batteries polarity) and put the back cover back in place and tighten the screws. 2 AAA batteries are required.

4.5 Advanced clocking

Many audio sources can be connected to the CI. Depending on their type, and your CI options, different clocking scheme can be used. Some are simply not working at all (no sound will come out of your CI, e.g. because at least one unit doesn't lock its internal clock to the configured clock source), some others will work for some time before muting (e.g. in case more than one unit is clock master, i.e. configured to lock to its own internal clock), some others will work fine but won't be optimal depending on your hardware (e.g. using D1 as clock source and CI as clock slave when equipped with SYNC_IO boards, or engaging the asynchronous SRC with AES-compliant sources), while others will bring you the joy associated to pure musical emotion.

Recommended use cases for various configurations are detailed in the following paragraphs. Even though this chapter is quite technical, we kindly ask you to take the time to read it in order to get the best sound out of your CH system.

4.5.1 General clocking considerations

In any configuration, **there must always be no more and no less than one clock master**. In CH product range, the clock master is the unit clocked on its own internal clock (parameter clock source is INTERNAL). It can be a CH product, or an external clock generator. If more than one clock master is used, the system is no more synchronized (at some point a unit will display "CLOCKING ERR." to let you know the current clocking scheme is wrong and thus produces a clocking error). If the DAC is not working synchronously to its source, its input buffer will get completely full (is the source is slightly faster than the DAC) or completely empty (if the source is slightly slower than the DAC) after some time.

If there isn't any clock master, each unit gets synchronization from a unit that is clock slave itself. This kind of system is not stable, and may either never output sound, or unlock after some time. If the configured clock source (e.g. SYNCHRO BNC 75 Ohm) is not connected or has no synchronization signal, the C1 can not lock (open padlock symbol displayed) and mutes its output.

4.5.2 Without SYNC_IO board

When a C1 with no SYNC_IO board is used together with a CH D1 SACD/CD transport (or other standard S/PDIF audio sources), both audio data and clocking goes from the source to the DAC. More precisely, clocking is sent with the audio stream. It is either carried on dedicated lines in the CH Link HD (while audio data is carries on other lines in the same cable) or embedded in S/PDIF's bi-phase modulated signal. Schematic below shows optimal way to connect such system:

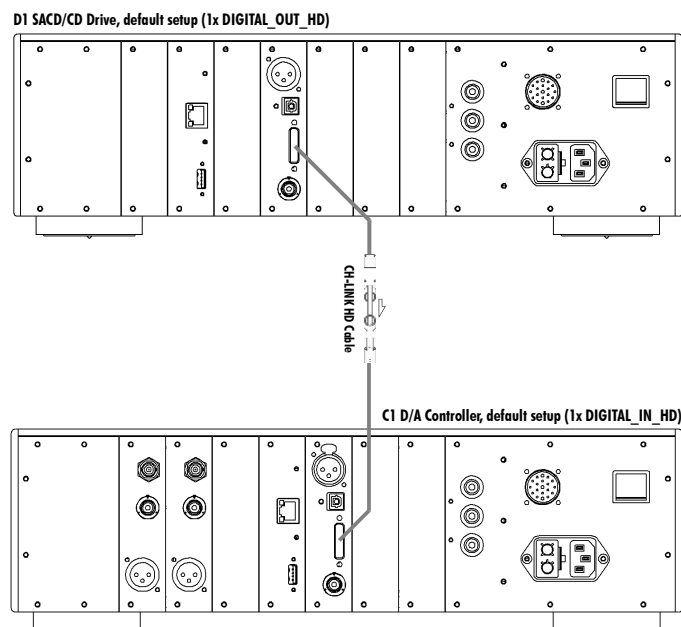

Simple D1 - C1 connection

More generally, when a C1 has no SYNC_IO board, it can only clock itself to the incoming audio stream (clock source is AUDIO IN) when playing a CH-Link HD, AES EBU, COAXIAL or OPTICAL input. The same applies for multichannel setup when CH products have no SYNC_IO board. In such case:

- D1 clock source: INTERNAL
- C1 clock source (for this input): AUDIO IN

If in this configuration (clock source = AUDIO IN) the C1 is not able to lock (open padlock) on an incoming S/PDIF audio stream but properly detects its sampling frequency (a valid Fs is displayed instead of "Fs UNKNOWN" in the upper left corner of its display), it probably means that the S/PDIF source does not comply with AES standard and/or has too much jitter. To overcome this problem, set the clock source as "SRC" for this input. It will add an asynchronous sample rate conversion stage that has a wider locking range.

4.5.3 C1 D/A controller (with SYNC_IO board) + D1 SACD/CD drive (with SYNC_IO board)

When both the C1 and the D1 are equipped with a SYNC_IO board, optimum performance are obtained when the C1 DAC is the clock master, and the D1 drive is the clock slave. Audio stream goes from the D1 to the C1, but clock goes the other way. Schematic below shows to connect such system:

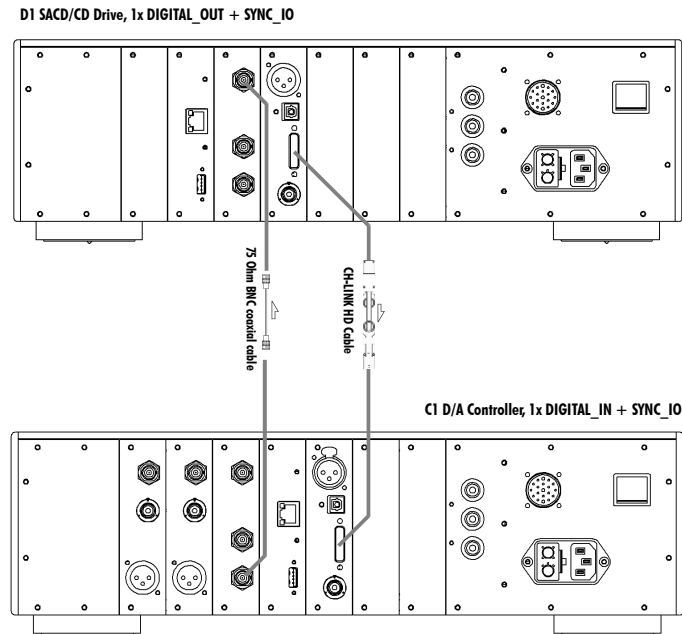

D1 - C1 connection when SYNC_IO equipped

When paired with a hybrid configured D1 (DIGITAL_OUT L/R + ANALOG_OUT Ls/RS and C/Sub), recommended setup is still the same (i.e. clock goes from C1 to D1 to have optimal conversion condition for main channels). In such case:

- D1 clock source: SYNCHRO BNC 75 Ohm
- C1 clock source (for this input): INTERNAL

4.5.4 3x C1 D/A controllers + multichannel D1 drive (all with SYNC_IO board)

In this 4-unit multichannel setup (D1 with all 6 channels digital out + 3 C1 DAC pairs), when all units are equipped with SYNC_IO boards, we still recommend that the C1 processing the main channels is the clock master. The D1 is slaved to this C1's clock, and generates a synchronization signal for the two other C1s (Ls/Rs and C/Sub ones). Schematic below shows optimal way to connect such system:

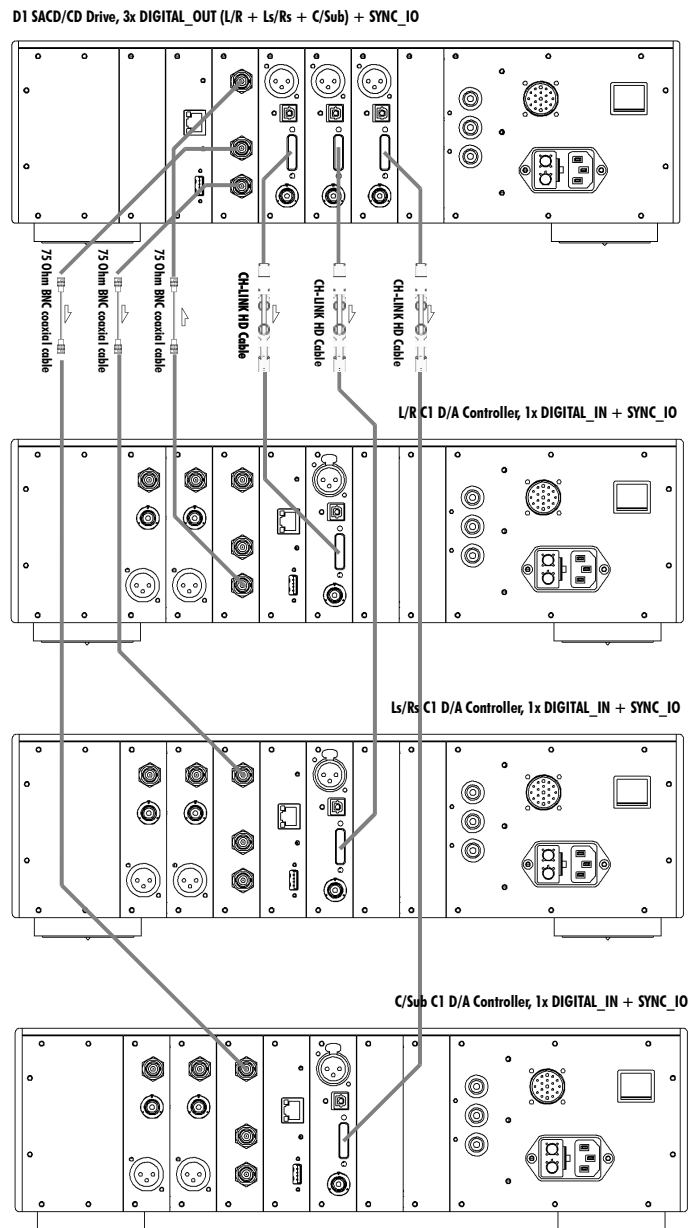

Multichannel D1 - C1 connection when SYNC_IO equipped

In such case:

- D1 clock source: SYNCHRO BNC 75 Ohm
- L/R channels C1 clock source (for this input): INTERNAL
- Ls/Rs channels C1 and C/Sub channels C1 clock source (for this input): SYNCHRO BNC 75 Ohm

4.5.5 D1 (with SYNC_IO board) + C1 (with SYNC_IO board) + T1 time reference

When both the D1 and the C1 are equipped with a SYNC_IO board, and an ultra-high stability clock generator such as the CH Precision T1 10MHz time reference is available, optimum performances are obtained when both the D1 and C1 lock themselves onto the external clock generator. Direct clock connections from the T1 to the devices is preferred over daisy-chaining. Audio stream goes from the D1 to the C1, and clock is distributed to both D1 and C1 from the T1. If more DACs are available for extra surround channels, they should also be connected directly to the clock generator. Schematic below shows how to connect such system:

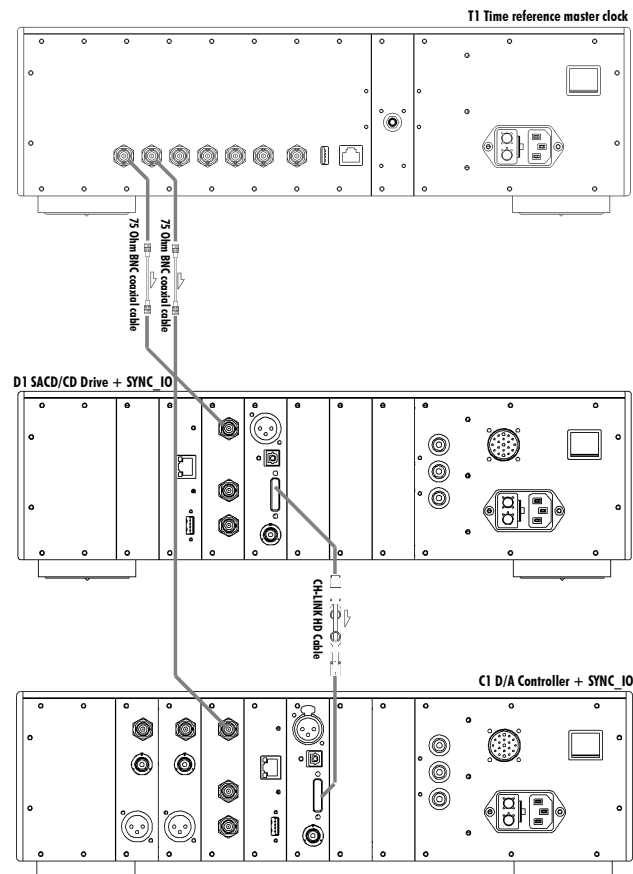

D1 – C1 – T1 connection when SYNC_IO equipped

The same applied if the D1 has multi-channel capability and more DACs are connected to the D1 for surround, center and sub channels. In such cases:

- D1 clock source: SYNCHRO BNC 75 Ohm
- C1 clock source (for this input): SYNCHRO BNC 75 Ohm

4.5.6 C1 D/A controller + Computer (USB audio)

When a C1 equipped with a USB_IN board is used together with a computer for audio files playback, a single link is in place between them: a type A (computer side) to type B (C1 side) USB 2.0 cable. But this single link enabled data to flow from the computer to the C1, while the C1 give the pace of the data transfer, thus being clock master. Schematic below shows how to connect such system:

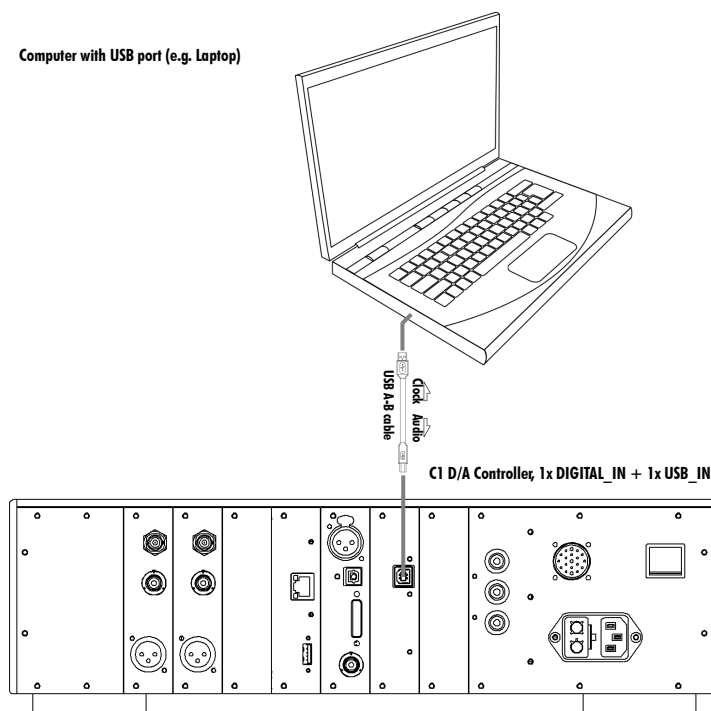

USB Computer to C1 connection

In such case:

- C1 clock source (for this input): INTERNAL
- C1 clock source when using T1 (for this input): Synchro BNC 75 Ohm

4.5.7 C1 D/A controller + Server (Ethernet audio playback)

When a C1 equipped with a ETHERNET_HD board is used together with a computer for audio files playback, a single link is in place between the C1 and the computer network: an RJ45 Ethernet cable. This single link enables data to flow from the network to the C1, while the C1 provides the pace of the data transfer, thus being clock master. Two Ethernet streaming inputs are available with

the ETHERNET_HD board: Roon Ready and ETHERNET. When using Roon as the music management and file server, select Roon Ready as the digital input on C1. A Roon Server attached to the same LAN as the C1 will recognize the ETHERNET_HD card as a Roon Ready endpoint and allow the C1 to be selected as a Roon audio zone. Select the ETHERNET input to stream files to the C1 using a local LAN attached UPnP/DLNA music server. The schematic below shows how to connect such systems:

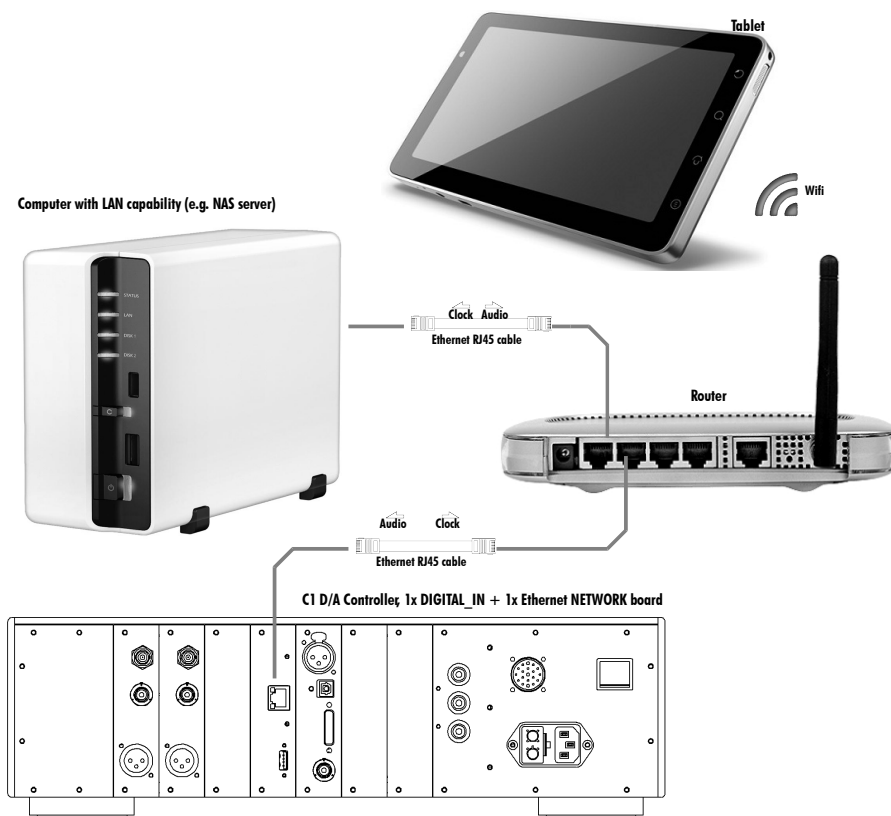

C1 connection to home network

In such case:

- C1 clock source (for this input): INTERNAL
- C1 clock source when using T1 (for this input): Synchro BNC 75 Ohm



4.6 Returning to factory defaults

The unit can be reset to Factory default settings by using the RESET ALL SETTINGS item of the FACTORY SETTINGS menu. For a list of Factory default settings, please refer to the Specifications section.

5 Firmware update

5.1 Preparing the USB stick

The firmware of all the CH Precision units can be updated using the USB port located at the back of the unit. Before starting the firmware update, it is necessary to load a USB stick with files containing the new firmware. Use the FAT32 formatted USB 2.0 stick provided with you C1. Please note that some USB sticks might not be detected by the C1 USB port. CH Precision recommends the use of Sandisk USB 2.0 sticks such as the one delivered with the unit.

The following procedure describes how to load the USB stick with the correct files:

1. Download the latest C1 firmware file from www.ch-precision.com
2. Decompress the .zip file and copy the decompressed files to the root of your USB stick.

Make sure all these files are present at the root of your USB stick, and that only one version of these files is present. Any missing file will make the firmware update procedure fail, while multiple versions of the same unit's firmware can lead to unstable unit behavior after update. So, delete the content of the USB key prior to copying the decompressed files.

5.2 Updating the unit's firmware

1. Perform the operations described in section 5.1
2. Connect the USB stick to the USB port located at the back of your C1 unit
3. Navigate to the FACTORY SETTINGS menu (see section 4) and select the UPDATE FIRMWARE item
4. Start the Firmware Update process by pushing the encoder button. Please note that the unit will perform a Reset (the display briefly turns off and on) during the procedure
5. Once the firmware update is complete, the unit automatically goes into Standby mode. Remove the USB stick and turn the unit on. The new firmware is now active. To verify that the firmware update is effective, navigate to the FACTORY SETTINGS menu and select the FIRMWARE VERSION item. The displayed firmware revision should match the firmware revision on the files copied to the USB stick

Note: The firmware update process lasts 6-15 minutes, **do NOT interrupt it!**



When performing a firmware update, do NOT press or turn any of the unit's front panel button/encoder, do NOT unplug the unit from the AC wall socket and do NOT turn the mains power switch off. Interruption of the firmware update procedure may result in corrupted firmware and a malfunctioning unit. In case something went wrong during a firmware update and the unit is malfunctioning, apply the emergency firmware update procedure described in the next section.

5.3 Emergency firmware update procedure

Perform the following Emergency Firmware Update procedure if your unit doesn't power up normally.

1. Perform the operations described in section 5.1
2. Power the unit off (back panel mains power switch to OFF)
3. Push and keep the encoder button pushed and power up the unit (back panel mains power switch to ON). Keep the encoder button pushed for a couple more seconds after you turned the unit on.
4. The unit performs the emergency firmware update. Once the operation is complete, the unit automatically goes into Standby mode. Remove the USB stick and turn the unit on. The new firmware is now active. To verify that the firmware update is effective, navigate to the FACTORY SETTINGS menu and select the FIRMWARE VERSION item. The displayed firmware revision should match the firmware revision on the files copied to the USB stick
5. If the emergency firmware update procedure fails, try the same procedure again using a different USB stick. If the failure persists, turn off your unit and contact your authorized dealer for assistance.

Note: The emergency firmware update procedure lasts 6-15 minutes, **do NOT interrupt it!**



6 Troubleshooting

| Error | Action |
|---|--|
| No power | Check the AC power cord Check the power button at the back of the unit Check the mains fuse on the AC power cord receptacle |
| Remote control does not work | Check if the unit is connected to the AC wall outlet and powered-on Check if distance is not too far to the CI unit. Get closer and try again. CI's Standby LED should briefly illuminate Change batteries in remote control if required (Remote control LED does not illuminate) Make sure the CI is not configured as Slave on the network (Settings / Network / Config) Make sure Factory Settings / Remote control matches your RC5 remote control (Pre2 by default) |
| No sound (general) | Check that your source is playing Check that your amplifier is turned-on and speakers are connected Check that the system volume setting is not too low Check that the correct input is selected on your CI |
| No sound ("Ⓜ" is displayed) | Your CI is muted (display area 2 Ⓜ must be off). Unmute using first RC button |
| No sound ("Fs UNKNOWN" is displayed) | There is no incoming digital stream for the selected input, or it is at an unsupported sampling frequency. Check supported audio format in the specification table (chapter 7.1). Try switching to another input to verify that your CI works well on other inputs. |
| No sound ("INVALID SIGNAL IN" is displayed) | Incoming audio stream is non-PCM (e.g. AC3 or DTS). Only play PCM on standard digital input, and PCM or DSD on CH-Link and ethernet streaming inputs. |
| No sound ("^■" is displayed) | CI is not locked to its clock source (symbol 7 should be a closed padlock). Please refer to advanced clocking chapter 4.5 for details on valid clocking combinations. If you are using a clocking scheme involving external clock in/out (SYNC_IO optional board), make sure 75 Ohm BNC cable is properly connected and not damaged. |
| No sound ("CLOCKING ERR." is displayed) | The source (e.g. D1 SACD/CD drive) and the CI are not synchronized. Please refer to Advanced clocking chapter 4.5 to make sure a valid clocking scheme is used. If you are using a clocking scheme involving external clock in/out (SYNC_IO optional board), make sure 75 Ohm BNC cable is properly connected and not damaged. |
| "ADC OVERFLOW" is displayed for a short time | The voltage exceeded 6V RMS at the input of the CI. If it is only triggered by the landing of the needle of the cartridge on the record (which produces a short signal overshoot), it is perfectly normal. If this message appears in other conditions, it means that the global voltage level of the analog source is too high and should be decreased |
| "ADC OVERFLOW" is displayed for a long time while playing | If the phono stage has no subsonic filter, the rumble noise boosted by the RIAA correction curve can lead to extremely high amplitude voltage swing at the input of the ADC, saturating |



| | |
|---|--|
| records. | it. In this case, use a subsonic filter of decrease the gain of the phono stage. |
| Lost in the settings? | Restore factory settings and start your setup again |
| Firmware update fails | Try Emergency Software Update procedure If it fails, download the latest C1 firmware from www.ch-precision.com , prepare a software update image on a FAT32 formatted USB stick and run the Emergency Software Update procedure again |
| USB flash drive for firmware update is not detected by C1 | Please try another brand of USB flash drive (e.g. Sandisk). |

Troubleshooting

If the error cannot be corrected using the information from the above table, disconnect the unit from AC wall power and from the rest of you system and contact your authorized dealer.



7 Specifications

| General | |
|--------------------------------------|---|
| Supported audio formats | <p>Standard digital inputs (AES-EBU, coaxial and optical):</p> <ul style="list-style-type: none">- Stereo consumer S/PDIF encoded PCM; 16 to 24 bits; 44.1, 48, 88.2, 96, 176.4 or 192 kHz- Stereo DSD (DoP) 1 bit; 2.8224 MHz (DSD64) <p>CH-Link HD:</p> <ul style="list-style-type: none">- Stereo I²S PCM; 16 to 32 bits; 44.1, 48, 88.2, 96, 176.4, 192, 352.8 (DXD), 384 (DXD), 705.6 or 768 kHz- Stereo cyphered DSD 1 bit; 2.8224 (DSD64) or 5.6448 MHz (DSD128) <p>USB (audio class 1.0):</p> <ul style="list-style-type: none">- Stereo PCM; 16 to 24 bits; 44.1, 48, 88.2, 96 kHz <p>USB (audio class 2.0):</p> <ul style="list-style-type: none">- Stereo PCM; 16 to 24 bits; 44.1, 48, 88.2, 96, 176.4, 192, 352.8 (DXD) and 384 (DXD) kHz- Stereo DSD (DoP) 1 bit; 2.8224 MHz (DSD64) and 5.6448 MHz (DSD128) <p>NETWORK (Ethernet):</p> <ul style="list-style-type: none">- Stereo PCM; 16 to 24 bits; 44.1, 48, 88.2, 96, 176.4, 192, 352.8 (DXD) and 384 (DXD) kHz, WAV, AIFF, FLAC, ALAC, MP3 and AAC files- Stereo DSD 1 bit; 2.8224 (DSD64), 5.6448 (DSD128) or 11.2896 MHz (DSD256), DFF and DSF files |
| User control | Dual concentric rotary knob with push function (control knob) and CH Control Android app |
| Display | 480 x 272 24bits RGB AMOLED |
| Power supply | Selectable 100V, 115V or 230V AC, 47Hz to 63Hz |
| Power consumption (Standby) | < 1W |
| Power consumption (Normal operation) | Max 100W |
| Operating conditions | Temperature: +5C to +35C, humidity: 5% to 85% (no condensation) |
| Dimensions (L x D x H) | 440mm x 440mm x 120mm (main body) 440mm x 492mm x 160mm (overall including connectors and feet) |
| Weight | 25kg |
| Firmware update / Control | USB port for firmware update / Ethernet based system control |
| Analog output stage | |
| Balanced outputs | XLR connectors |



| | |
|--|--|
| Single-ended outputs | RCA connectors BNC connectors |
| Output level | 5.4Vrms (balanced) 2.7Vrms (unbalanced) |
| Frequency response (-3dB point) | DC-120kHz (balanced and unbalanced, digital filter dependent) |
| Dynamic Range (DNR) | 120dB (balanced and unbalanced) |
| Signal to Noise Ratio (SNR) | 123dB (balanced and unbalanced) |
| Total Harmonic Distortion + Noise (THD+N) | <0.0015% (balanced and unbalanced) |
| Digital Audio inputs (DIGITAL_IN board, four stereo inputs per board) | |
| CH LINK HD | Proprietary high-definition link supporting high-definition uncompressed audio and control. Cyphered operation for high resolution signals (DSD). LVDS signaling for all I ² S audio signals (incl. clocks). PCM 16-32 bits / 44.1-768 kHz; DSD 2.8224 or 5.6448 MHz |
| AES-EBU (consumer format) | XLR connector, 0.5-5Vpp diff., 110 Ohm PCM 16-24 bits / 44.1-192 kHz DSD (DoP) 1 bit 2.8224 MHz |
| Coaxial (S/PDIF) | RCA connector, 0.1-1Vpp, 75 Ohm PCM 16-24 bits / 44.1-192 kHz DSD (DoP) 1 bit 2.8224 MHz |
| Optical TOSLINK (S/PDIF) | Standard TOSLINK optical connector PCM 16-24 bits / 44.1-192 kHz DSD (DoP) 1 bit 2.8224 MHz |
| USB Audio input (USB_IN board, one connector per board) | |
| USB Audio Class 1.0 (A-type plug) | Asynchronous playback (C1 master, computer slave) PCM 16-24 bits / 44.1-96 kHz |
| USB Audio Class 2.0 (A-type plug) | Asynchronous playback (C1 master, computer slave) PCM 16-24 bits / 44.1-384 kHz DSD (DoP) 1 bit 2.8224-5.6448 MHz |
| Ethernet Audio input (ETHERNET_HD board) | |
| Audio file types | WAV, AIFF, FLAC, ALAC, MP3, AAC, DFF, DSF |
| Audio formats | Stereo PCM 16-24 bits / 44.1-384 kHz Stereo DSD 1 bit / 2.8224-11.2896 MHz |
| Analog Audio inputs (ANALOG_IN board, two stereo inputs per board) | |
| Balanced input pair | True balanced XLR connectors |
| Single-ended input pair | RCA connectors |
| Maximum input level | 4Vrms (balanced) 2Vrms (single-ended) |



| | |
|--|---|
| A/D conversion stage | 1 bits / 5.6448 kHz |
| Synchronization inputs and output (SYNC_IO board) | |
| Clock input | 1 x BNC connector, 0.5Vpp to 5Vpp, 75 Ohm or high input impedance Wordclock (44.1, 48, 88.2, 96, 176.4, 192, 352.8, 384 kHz), Masterclock (22.5792, 24.476 MHz), DSD bitclock (2.8224 MHz), High stability external clock (100 kHz, 10 MHz), 40% to 60% duty cycle square wave |
| Clock output | 2x BNC connectors, 2Vpp, 75 Ohm output impedance Buffered Clock input or Audio Wordclock 50% duty cycle square wave |
| Remote control | |
| Remote control type | Infrared. Uses RC5 codes. Range: 10m (line of sight) |
| Remote control batteries | 2x AAA type |

Design and Specifications are subject to change without notice. Weight and dimensions are approximate

Illustrations are informative only and may differ from the actual production model

Enclosure designed by Mana Ishoni

FCC-Notice

Note: This equipment has been tested and found to comply with the limits for a Class B digital device, pursuant to Part 15 of the FCC Rules. These limits are designed to provide reasonable protection against harmful interference in a residential installation. This equipment generates, uses and can radiate radio frequency energy and, if not installed and used in accordance with the instructions, may cause harmful interference to radio communications. However there is no guarantee that interference will not occur in a particular installation.

If this equipment does cause harmful interference to radio or television reception, which can be determined by turning the equipment off and on, the user is encouraged to try to correct the interference by one or more of the following measures:

- adjust or relocate the receiving antenna
- increase the separation between the equipment and the receiver
- connect the equipment into a mains outlet on a circuit different from that to which the receiver is connected
- consult the dealer or an experienced radio/TV technician for help

Disposal – Environmental care

Directive 2002/96/EG of the European Parliament requires consumer electro-technical appliances to be disposed separately and have to be indicated with the following symbol. Should you dispose this component please do so in conformity with local and global legal and environmental regulations and according to best practices. We strongly encourage you to recycle any batteries used with this component.

